

CESeasy

Door controller



Assembly and Operating Manual



English

Version VB

BRO2279-1

Contents

1 About this manual	4
1.1 Design characteristics	4
1.2 Target group of this manual	4
2 Manufacturer's information	5
2.1 Manufacturer and service	5
2.2 Manufacturer's warranty	5
3 For your safety	6
3.1 EU Declaration of conformity	6
3.2 Intended use	6
3.3 Basic safety instructions	6
3.4 Notes on dealing with batteries	7
4 CESeasy door controllers	9
4.1 About door controllers	9
4.2 Scope of application	9
5 Scope of delivery	10
6 Assembly	12
7 Connections	15
7.1 How to connect the device to be controlled	15
7.2 Additional connections	16
8 Batteries	17
8.1 Required batteries	17
8.2 Battery consumption	17
8.3 Battery warnings	18
8.4 How to insert and change batteries	19
8.5 Battery disposal	19
9 Configuration	20
9.1 CESeasy app	20

9.2 Coupling	21
9.3 Configuration menu	24
10 Firmware update	28
10.1 Automatic firmware updates	28
10.2 Manual firmware updates	28
11 Administration	29
11.1 CESeasy web platform	29
11.2 Extension functions	29
12 Operation	32
12.1 Operation via smartphone	32
12.2 How to use it with a remote control	33
13 Technical data	34
13.1 Equipment features	34
13.2 Dimensions	35
14 Optional accessories	36
14.1 Door contact	36
14.2 Power supply unit	37
15 Disposal	38
15.1 Notes on disposal	38
16 Index	40

1 About this manual



These assembly and operating instructions, hereinafter referred to as the “manual”, will help you with the assembly and in a proper, safe, and beneficial use of the CESeasy products acquired.

Anyone who assembles, administers, maintains, or disposes of CESeasy products, must have read and understood the complete contents of this manual.

If you do not understand the functions of the CESeasy products, please contact your CES partner for further information.

-  Always use the latest version of this manual. The version number of this manual is shown on the cover page. You can get the latest version free of charge from www.ces.eu

1.1 Design characteristics

-  Refers to other documents.
-  Marks additional information and tips.
-  Marks warnings in step-by-step instructions and specially important information.

1.2 Target group of this manual

This manual is intended for

- Trained service and assembly personnel
- Maintenance personnel
- Operators

The necessary expertise regarding the intended use of the product is presumed for the use of this manual.

The necessary product training is conducted by your CES partner. If this has not yet taken place, please contact your CES partner to get the product training.

2 Manufacturer's information

2.1 Manufacturer and service

C.Ed. Schulte GmbH

Zylinderschlossfabrik

Friedrichstr. 243

42551 Velbert

Tel: +49 (0) 2051-204-0

Fax: +49 (0) 2051-204-229

www.ces.eu

2.2 Manufacturer's warranty

The following damage is not covered by the manufacturer's warranty:

- Damage to the exterior mechanical parts as well as subsequent damage arising from normal wear and tear.
- Damage caused by external events or influences
- Damage caused by deficient assembly
- Damage caused by deficient maintenance
- Damage caused by false operation
- Damage caused by overvoltage
- Damage caused by fire, water or smoke

All technical data and features are subject to change without prior notice. All information and data contained in this document is subject to change without prior notice. Without express written approval from C.Ed. Schulte GmbH Zylinderschlossfabrik, no part of this document may be copied or transmitted for any purposes whatsoever.

© 2018 C.Ed. Schulte GmbH Zylinderschlossfabrik, Velbert/Germany

VB

BRO2279-1

3 For your safety

3.1 EU Declaration of conformity

You can find the EU Declaration of conformity on the Internet at www.ces.eu.

3.2 Intended use

CESeasy products are intended to control access at doors. They are exclusively intended for this purpose and may only be used for this. They may never be altered in any way without written permission from C.Ed. Schulte GmbH Zylinderschlossfabrik.

All other uses are regarded as improper use and may lead to material damage or even personal injuries. C.Ed. Schulte GmbH Zylinderschlossfabrik assumes no liability for damage caused by improper use.

3.3 Basic safety instructions

CESeasy products have been built with state-of-the-art technology and established safety regulations. Nevertheless, their use may constitute function-related hazards for the user or third parties and may impair the handle set and other material assets.

Please observe all warnings and notices in this manual while assembling, configuring and using CESeasy products.

3.3.1 Life-threatening danger

- CESeasy products have not been developed, tested and/or approved for access in life-threatening situations. Do not use CESeasy products on fire doors or panic doors.
- CESeasy products must be suitable for your door system. If you are in doubt, please contact the manufacturer of the door or lock to check suitability.
- All components which are required for a complete installation at your door must be CE-compliant. Please check before installation whether all components used are CE-compliant.

3.3.2 Danger of personal injury

Danger of explosion

- Live parts may cause explosion. Do not use parts in potentially explosive areas.

3.3.3 Danger of damage to material assets

Transportation

- Do not drop the device on the floor, on hard surfaces or objects.

Assembly

- The device contains highly sensitive electronic components, which can be damaged or destroyed through electrostatic charges. Therefore, do not assemble the handle set in areas affected by electrostatic charge.
- For assembly and dismantling, use the tools indicated in the "Assembly" section only.
- Only use a dry or protected or indoors place for device installation.

Operation

- Protect the electronic components against water and other fluids.

Maintenance

- Always have repairs performed by qualified personnel.
- Use only the accessories and spare parts recommended by CES.

Danger through climatic influences

- Do not use the device in corrosive atmosphere (chlorine, ammonia, lime water)
- Do not use the device in areas with high dust formation.
- Do not use the device near heat sources.

Please observe the maximum permissible temperatures and the information on air humidity in the section "Technical Data".

3.4 Notes on dealing with batteries

- Always insert new batteries only. Never use old and new batteries together.
- Before inserting the batteries, check whether the contacts in the device and on the batteries are clean. Otherwise, clean them. Do not touch the contacts after the cleaning process.
- When inserting the batteries, ensure that the polarity is correct (+/-).
- Never try to recharge the batteries. There is a risk of explosion!
- Do not short-circuit the batteries.
- Store batteries in a cool and dry place. Direct heat may damage the batteries. Therefore, do not expose battery-operated devices to any strong heat source, and do not throw the batteries into fire.

- If you do not use devices for a longer time, take out the batteries.
- Remove leaking batteries immediately from the device. Clean the contacts before inserting new batteries. There is danger of injury from battery acid.
- Remove the empty batteries from the device.
- Please take note of the information on battery disposal (see "[Disposal](#)" on page 38).

4 CESeasy door controllers

4.1 About door controllers

The CESeasy door controller allows you to control electronic locking systems (e.g. electronic locks, sliding doors, garage doors, barriers, etc.) with the CESeasy app or remote controls.

The universal door controller is the ideal solution to open and close doors, gates and locks which cannot be fitted with a CESeasy motor cylinder.

Example: In a residential building, all tenants have their apartment door equipped with a CESeasy motor cylinder. The tenants would also like to control the electrical garage door of the communal garage with the CESeasy app or a remote control. However, it is not possible to fit the garage door with a CESeasy motor cylinder, but it is possible to control the door electrically. For this reason the door controller can be fitted to the garage door. It can now be opened or closed with the CESeasy app or a remote control.

4.2 Scope of application

CESeasy door controllers can be used for a wide range of locking mechanisms which can be controlled electronically.



CESeasy products have not been developed, tested and/or approved for access to escape and emergency routes. Do not use CESeasy products on fire doors or panic doors.



The device must be installed in a dry and protected place in the building.

5 Scope of delivery



1	1 Door controller
2	1 Registration card (incl. extension function "Lock owner (licence)", see " Extension functions " on page 29)
3	4 Batteries
4	1 Remote control (only part of the starter set)

Registration card

You will find important information on the registration card about your device, including the registration code. You need it to create a lock owner account or to add your device to the already existing lock owner account.

The registration card contains the following information:



Registration address

The URL you can use to create a lock owner account.

S/N

Serial number of the device. It must coincide with the serial number on your device:

For motor cylinders: Serial number on the sticker in the battery compartment and on the back of the motor cylinder.

For door controllers: Serial number on the sticker in the casing beneath the battery compartment and on the back of the door controller.

Bluetooth MAC address

The unique Bluetooth MAC address of the device.

Registration code

You need this code to register your device in your lock owner account. If you do not have a lock owner account yet, you need the registration code to create your lock owner account.

-  Keep your registration card in a safe place. You will need it in a service situation, or if you want to transfer the lock to another lock owner account.

6 Assembly

Notes on the installation

- Install the door controller next to the door that is to be controlled by it.
- The device must be installed in a dry and protected place in the building.

Tools required

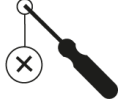
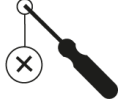
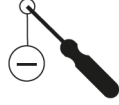
Tool		Required for
	PH1 Phillips screwdriver	Open the cover
	PZ2 Phillips screwdriver	Wall assembly
	0.5 mm x 3 mm slot-head screwdriver	How to connect the ports

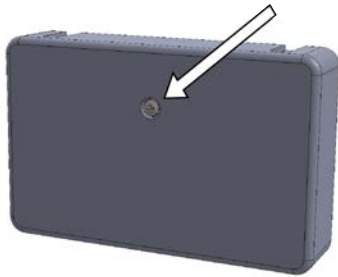

How to install the door controller

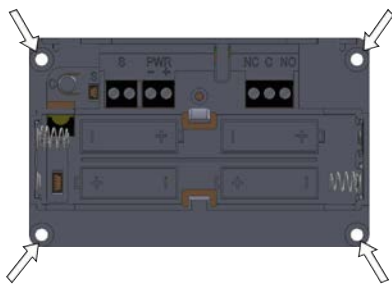

1. Use the PH1 screw driver to loosen the screw in the cover of the door controller, and pull off the cover.



2. The door controller case contains four assembly openings. Attach the door controller with at least two 4mm countersunk head screws to a level surface.

-  The length of the screws depends on the surface.
-  Depending on the surface you may have to use suitable dowels.

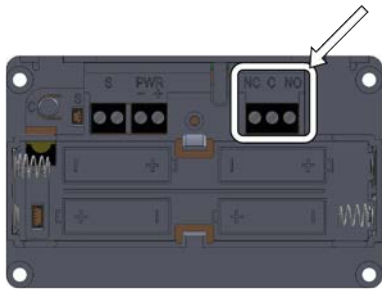

3. Then connect the device to be controlled with the door controller (see ["How to connect the device to be controlled"](#) on page 15).

4. (Optional) If you want to connect optional accessories to the door controller, you have to connect the accessories (see ["Optional accessories"](#) on page 36).

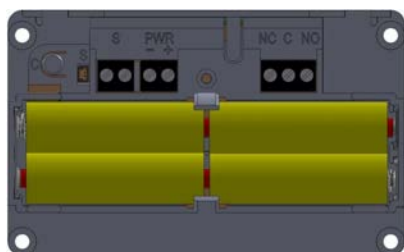

5. Insert the batteries (for details about batteries, please refer to section ["Batteries"](#) on page 17.)



6. Carry out a firmware update (see "[Manual firmware updates](#)" on page 28).

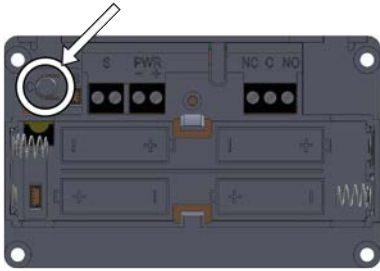

7. Then configure the door controller (see "[Configuration](#)" on page 20).

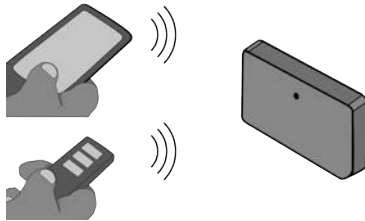

8. Check if the door controller is working correctly.

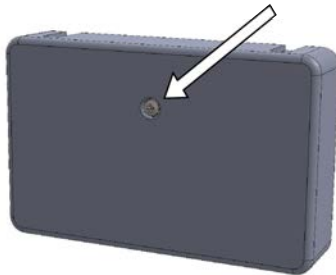

9. Screw the cover back onto the case.

The door controller is now completely mounted and ready for use.

7 Connections

7.1 How to connect the device to be controlled

The door controller is equipped with a relay which allows to control a device (e.g. electrical door locks). The relay output is a potential-free changeover contact.

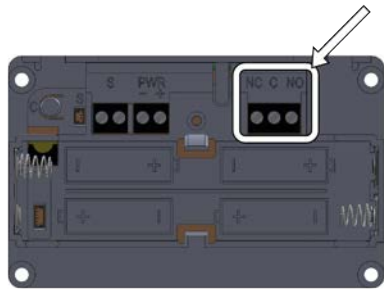

The relay contact is located at the three-pole screw terminal which is labelled with NC, C, and NO.

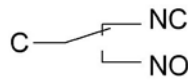

NC = normally closed
 C = common
 NO = normally open

How to connect the relay contacts

Maximum voltage:	30 VAC or 30 VDC
Maximum current:	1.5A (ohmic load).

 Please always note the instructions of third-party manufacturers when you connect their devices.

 When you want to switch **inductive loads** like magnets, relays, coils, etc. **always use a flyback diode** directly on the load. The device may be damaged if no flyback diode has been used, or if it was connected falsely!

Examples which show how to connect an inductive load to a flyback diode

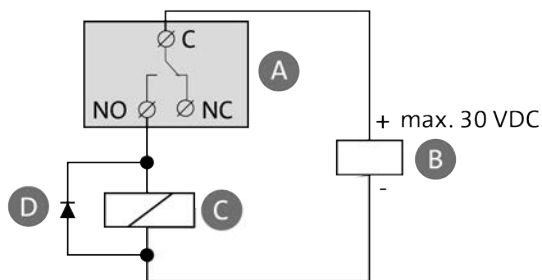

- A: relay of the door controller
- B: power source of the lock
- C: inductive load
- D: flyback diode

7.2 Additional connections

You can connect optional accessories to the additional outputs:

- Door contact (see "[Door contact](#)" on page 36)
- Power supply unit (see "[Power supply unit](#)" on page 37)

8 Batteries

8.1 Required batteries

You need 4 AA alkaline batteries.

8.2 Battery consumption

Four new batteries will last for 100,000 opening and closing operations in one year (at 20°C).

Battery consumption of the door controller depends, amongst other things, on the following factors:

- Quality and capacity of the batteries. The higher the capacity, the longer the batteries will last.
- If connected to a power supply unit. If a power supply unit is connected, the batteries are used only if no voltage is applied.
- The frequency at which the relay is switched. Because a bi-stable relay is used, the time the relay contacts are in a certain position does not influence the battery consumption.
- Ambient temperature. If ambient temperatures are lower, battery service life will be reduced.

8.3 Battery warnings

Battery warning by the door controller

If the batteries are nearly empty, the device emits the usual acoustic signal after an opening or closing operation, and then three acoustic battery warning signals (--- --- ---).

-  The battery warning signals are also emitted if you have switched off the normal acoustic signal via the configuration settings.

Battery warning in the CESeasy app

If the batteries are nearly empty, a pop-up window opens in the CESeasy app after an opening or closing operation which informs you about the battery status.

-  If the battery warning shows that the batteries are nearly empty, the door controller will continue to work for some more time. However, the duration of this period depends strongly on the aspects mentioned in the section "[Battery consumption](#)" on the previous page.

8.4 How to insert and change batteries

Tools required

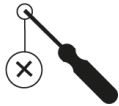
Tool		Required for
	PH1 Phillips screwdriver	Open the cover

How to insert and change batteries

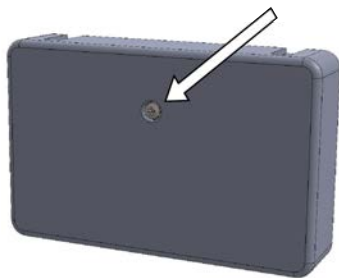

1. Use the PH1 screw driver to loosen the screw in the cover of the door controller. Pull off the cover.

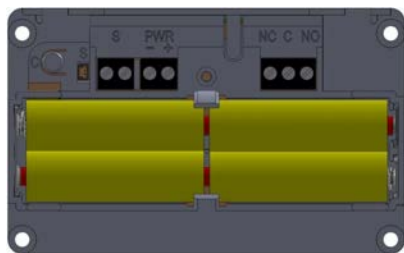

2. If necessary, take out the four empty batteries. Insert the four new batteries.

 Please ensure that the batteries are inserted according to the labelling in the battery compartment which indicates the correct polarity.

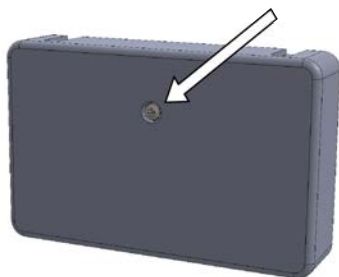

3. Screw the cover back onto the case.

The batteries are now inserted or have been changed.

8.5 Battery disposal

See "Disposal" on page 38.

9 Configuration

-  It is recommended to have CESeasy products installed and configured by CES partners. They are not only familiar with the products, but rather also with your door. Therefore, they can guarantee that the devices work correctly.

9.1 CESeasy app

For configuration you need the CESeasy app.

The CESeasy app is available for Android and iPhone. Simply scan the QR code to download the app.

-  The QR code is able to detect whether you are using an Android phone or iPhone, and refers you to the correct app.



CESeasy app "access"



If the scan does not work, please open the following link on your smartphone. The link is also able to detect whether you are using an Android phone or iPhone, and refers you to the correct app.

<https://ces.qr1.at/CESeasyApp>

Smartphone prerequisites:

- iOS (iOS 9.2 or higher) or Android (Android 4.4 or higher)
 - If you use an iPhone: iPhone 4S or newer models
- Bluetooth 4.0 or higher
- suitable for Bluetooth Low Energy

Location transmission

To enable the CESeasy app to connect to the lock, the location transmission must be activated. This applies to both the settings of **the app itself** (CESeasy app must be allowed to share the location) and the location transmission **of your smartphone** (location transmission must be activated for the smartphone).

-  If you use an Android smartphone, you may have to set the location transmission once manually in the settings of the CESeasy app after it has been installed.

9.2 Coupling

For safety reasons, the door controller has to be connected to the app for manual firmware updates and configuration. Thus, only people with direct access to the door controller can update and configure it.

Tools required

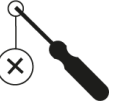
Tool		Required for
	Smartphone with CESeasy app Smartphone prerequisites: <ul style="list-style-type: none"> • iOS (iOS 9.2 or higher) or Android (Android 4.4 or higher) <ul style="list-style-type: none"> • If you use an iPhone: iPhone 4S or newer models • Bluetooth 4.0 or higher • suitable for Bluetooth Low Energy 	Configuration, firmware update and test
	PH1 Phillips screwdriver	Screw in cover

How to couple the door controller with the CESeasy app

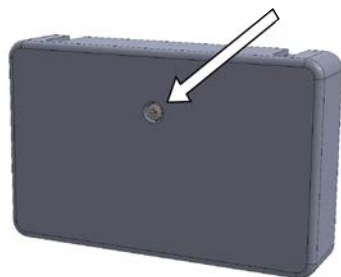

1. Use the PH1 screw driver to loosen the screw in the cover of the door controller, and pull off the cover.

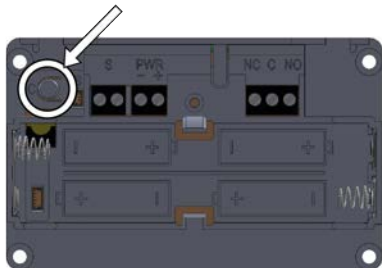

2. Press the coupling button in the case of the door controller for approx. 1 second.

Now, the door controller periodically emits an acoustic signal.

 The door controller has to be within the range of the smartphone.



3. Open the CESeasy app on your smartphone.



4. Make sure you are in the “Locks” menu of the app. Click on the “Scan” button  in the upper right corner.

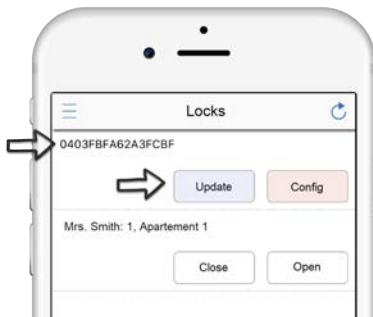

In the menu options “Update” and “Config” you will now see the door controller.

 As long as the door controller is connected to the app, it regularly emits an acoustic signal. This shows that both are connected.



5. If you click on “Config”, the configuration menu opens (see ["Configuration menu"](#) on page 24).

 Make sure that you have carried out the **first** firmware update **before** configuring the device. Otherwise, your configuration will be overwritten by the first firmware update. No subsequent firmware updates will overwrite your configuration.

6. If you click on “Update”, a firmware update is carried out (see ["Firmware update"](#) on page 28).



9.3 Configuration menu

-  Make sure that you have carried out the **first** firmware update **before** configuring the device. Otherwise, your configuration will be overwritten by the first firmware update. No subsequent firmware updates will overwrite your configuration.

Test



For safety reasons, always test the functions when the door is open!

Open Unlocks the lock

Close Locks the lock



If the lock does not act in the desired manner for “Open” or “Close”, you can adjust this via the following configuration settings:

- How to change the lock control (see below)
- How to reverse the door contact (see below)



If it is not possible to achieve the desired results via the configuration settings, check if the NO and NC outputs of the relay are correctly connected to the lock (see ["How to connect the device to be controlled"](#) on page 15).

Configuration

Acoustic signal Acoustic signal after each closing/opening operation yes/no

Lock control Here you can set the way in which the lock is controlled, see ["Lock control"](#) on page 26.

Reaction time This menu item will be shown only for certain types of control, see ["Lock control"](#) on page 26.

Reaction time This menu item is relevant for certain types of control, see ["Lock control"](#) on page 26.

Using the door Here, if there is a door contact, you can define whether that door contact should be used.
status sensor

Reversing the Here you can reverse the signal of the door contact if the door contact signals “door open”
door status when the door is closed.
sensor

Type Lock type, e.g. motor cylinder or door controller

Power supply Indicates whether an optional power supply unit is connected or not.
unit

Battery Indicates the battery voltage measured in the device.

Firmware Shows the firmware version of the device.

Advanced Opens the expert menu for the CES service technician.



To ensure that only trained experts can change the settings in the expert menu, it is protected by a PIN code.

Advanced (expert menu)



Changes in the expert menu may lead to undesired behaviour by the door controller. Only change the settings if you know exactly what you are doing!

Reset to stand-ard settings	Resets the configuration settings to factory settings.						
Reaction time of door contact	Here you can set the time which has to expire between a status change of the door contact (door is either open or closed) and the device reaction to this status change.						
Transmission power	<p>Here you can reduce the Bluetooth transmission power.</p> <p>Example: A building contains 10 doors with CESeasy locks. If the locks are located relatively close to each other, a person with keys for all 10 locks will see a long, confusing list of locks in the CESeasy app. If you reduce the transmission power of the locks, the list of locks in the immediate vicinity will be reduced.</p>						
Command	The command line is intended to send commands to the device.						
Bluetooth MAC	Shows the bluetooth address of the device.						
Boot version	Here you can see the boot version of the device.						
Module status	<p>Indicates the connection status between device and communication module:</p> <table border="1"> <tr> <td>not connected</td> <td>The device is not coupled to a communication module</td> </tr> <tr> <td>connected</td> <td>Device is coupled to a communication module</td> </tr> <tr> <td>connected, communication error</td> <td>Device is coupled to a communication module, but there is a communication error</td> </tr> </table> <p> If the status is “connected” or “connected, communication error”, the button “decouple” will be additionally displayed. Pressing this button will decouple the device from the communication module.</p>	not connected	The device is not coupled to a communication module	connected	Device is coupled to a communication module	connected, communication error	Device is coupled to a communication module, but there is a communication error
not connected	The device is not coupled to a communication module						
connected	Device is coupled to a communication module						
connected, communication error	Device is coupled to a communication module, but there is a communication error						
Module version	<p>Indicates either the firmware version <i>for the</i> communication module, or the firmware version <i>in the</i> communication module.</p> <p>If the device is coupled to the communication module, and both have communicated, the current firmware version of the communication module is shown.</p> <p>If the devices have not communicated yet, the firmware version which will be transferred to the communication module during their next communication will be shown.</p>						
Data reset	Resets the configuration settings to factory settings, as well as any data in the device (events saved so far, database and clock).						
Test	Here you can check the functions “open” and “close”.						

9.3.1 Lock control

Fixed time period After having received the “Open” order, the relay is activated for a certain period of time. You can set this period of time in “Reaction time”. If you want to deactivate the relay before the time period has expired, you can do so using the “Close” command.

Example: You use the door controller for the electronic lock of your front door. If you click on “Open” in the app, the door can be opened for 10 seconds.

The door is activated until the “Close” command is received After having received the “Open” command, the relay is activated until it is deactivated again by the “Close” command.

 If you choose to use this kind of control, the additional menu item “Reaction time limit” will appear. If you activate it, you can enter a time period. The relay is automatically deactivated after the time period has expired.

Example 1: You use the door controller for the electronic lock of your shop. In the morning you click on “Open”. Your customers can now come in without the need to use the app or other keys. After closing time, you click on “Close”, and the door is closed.

Example 2: You use the door controller for the electronic lock of your garage door. If you click on “Open”, the door opens. Only when you click on “Close” will the door close again. This allows you to open or close the garage door safely, regardless of any time period.

The door is activated until it has opened  This function requires a door contact. After having received the “Open” command, the relay is activated until the door contact signals that the door is open. As soon as the door contact signals “door is open”, the relay is deactivated.

 If you choose to use this kind of control, the additional menu item “Reaction time limit” will appear. If you activate it, you can enter a time period. The relay is automatically deactivated after the time period has expired.

Example: You use the door controller for the main entrance of an apartment building. When a resident clicks on “Open” in the app, he or she can open the front door. As soon as the door has been opened, the relay deactivates, and the door cannot be opened again after the resident has passed through it. If a resident does not open the door despite having clicked on “Open”, you have set a time period of 30 seconds. This time period prevents the time between having clicked on “Open” and opening the door from becoming randomly long.

The door is activated until it is  This function requires a door contact. After having received the “Open” command, the relay is activated until the door contact signals that the door was opened and has been closed again. As soon as the door contact first signals

closed "door is open" and then "door is closed", the relay will be deactivated.

 If you choose to use this kind of control, the additional menu item "Reaction time limit" will appear. If you activate it, you can enter a time period. The relay is automatically deactivated after the time period has expired.

Example: You use the door controller for the electronic self-locking lock of your front door. If you click on "Open" in the app, the door can be opened until it is closed again by you. By opening and closing the door, the door contact has signalled "door is open" once and "door is closed" once. Then, the lock locks itself as soon as the door is closed. Because you have set a period of time, the lock locks itself automatically after 30 seconds even without "door is open" or "door is closed" having been signalled.

10 Firmware update

10.1 Automatic firmware updates

Automatic firmware update after installation

The first firmware update after installation should be carried out manually. However, if this has not happened, the firmware update is carried out automatically after the device has been operated by the CESeasy App. In this case, the CESeasy app shows a message, and the firmware update will be completed after approx. 45 seconds.

Automatic firmware updates during operation

Firmware updates are automatically transmitted during operation by the CESeasy app. As soon as the new firmware has been transmitted completely, the device operates on the new firmware. Usually you do not notice the updating process.

10.2 Manual firmware updates

The following situations require a manual firmware update:

- The door controller has been installed for the first time
- The door controller has been reset to factory settings

How to proceed

See "[Coupling](#)" on page 21.



 Make sure that you have carried out the **first** firmware update **before** configuring the device. Otherwise, your configuration will be overwritten by the first firmware update. No subsequent firmware updates will overwrite your configuration.

 A message is shown that the transmitted firmware has been installed once the firmware has been transmitted completely. The door controller emits a signal to indicate that the firmware installation has been completed. Firmware installation takes about 30 seconds.

11 Administration

11.1 CESeasy web platform

The device is managed on the CESeasy web platform. There you can issue keys, add remote controls, etc.

 For details, please refer to the [manual for the CESeasy web platform](#).

11.2 Extension functions

Several extension functions are available at CES.



You can purchase these functions in the form of a prepaid card which contains a code. Scratch the code off and add it to your lock or account.

Lock management (for locks)



 The “Lock management” function is part of the locks as delivered by CESeasy.

The “Lock management” function allows you to manage your locks for 5 years on the web platform without any restrictions. You can extend it for another five years by buying an additional “Lock management” function.

When “Lock management” has expired, lock management will be restricted:

- You can no longer issue keys for this lock, you can only retrieve them. (The keys issued before this period expired are preserved)
- It is no longer possible to link a lock to a button of the remote control. (Buttons linked to a lock before this period expired are preserved)
- If no lock in your account has the “Lock management” function any longer, you can no longer add a remote control.
(The remote controls added before this period expired are preserved)



 “Lock management” is linked to each lock.

-  The time starts to run upon the first lock registration. If you delete a lock, the functions linked to it continue to be activated, and time continues to run. If this lock is registered again, it is added to the account with the remaining time.
-  If you have activated the "5 additional keys" function for a lock, you can issue and retrieve these keys for the lock in question only within the validity period. The additional keys do not prolong the term of expiration.



5 additional keys (for locks)



This function provides you with five additional keys for one lock. Additional keys are only valid for the lock to which you have added this extension function.

-  You can issue additional keys for one lock as long as you can also issue the keys which were delivered to you together with the lock.
-  When you delete a lock you also delete all additional keys which were added to this lock. Afterwards, these additional keys cannot be added to another lock.



Key to organisation (for locks)

This function allows you to issue keys not only to individuals but rather also to organisations. The organisation which has received a key from you can pass it on to its employees.

-  This function is valid for five years. The time during which this function is valid starts to run after you have added this function to the lock. If you delete the lock, time continues to run. If this lock is registered again, it is added to the account with its remaining time.
-  The "Key to organisation" function can only be added and used if a valid "Lock management" function has been added to it. The "Lock management" function is part of the locks as delivered by CESeasy.



Building management (for lock owner accounts)

The "Building management" function allows you to manage buildings in the role of a building manager. Your account is extended with the tab "Buildings" which allows you to create buildings and to add locks to these buildings. If you own the "Building management" function, you can additionally define how the name of the lock is displayed on the web platform and in the CESeasy app.

The "Building management" function is used to extend two account types:



- If you extend a **lock owner account** with the “Building management” function, you have a lock owner account with building management.
- If you extend an **organisation account** with the “Building management” function, you have a lock owner account with building management in addition to your organisation account. You can switch between the accounts on the web platform.

The “Building management” function is valid for five years. It is linked to your lock owner account.



100 employees (for an organisation)

You can use the “100 employees” function in two ways:

- It allows you to manage 100 additional employees in your organisation. Initially, you can manage 100 employees per organisation, while this function allows you to manage 200 employees in your organisation (or even more, if you buy this function several times).
-  If you manage several organisations with your organisation account: these 100 additional employees are added only to the organisation you have selected when activating this function.
-  The “100 employees” function has a duration of five years.
- When the licence duration of your organisation has expired, you can prolong it by another five years with the “100 employees” function.



Organisation (for organisation accounts)

You can use the “Organisation” function in two ways:

- It allows you to create an organisation account. This account automatically creates an organisation with 100 employees.
- If you already own an organisation account, this function allows you to add another organisation with 100 employees.
-  One organisation has a validity of 5 years. To extend its validity by another 5 years, you have to add the function “100 employees” to this organisation.

12 Operation

12.1 Operation via smartphone



You can operate the door controller by means of the CESeasy app and a suitable smartphone.

To use the CESeasy app for operation, you need a digital key. This key is issued via the CESeasy web platform by the lock owner and forwarded per email.



For details, please refer to the [manual for the CESeasy web platform](#).

How to download the CESeasy app

The CESeasy app is available for Android and iPhone. Simply scan the QR code to download the app.



The QR code is able to detect whether you are using an Android phone or iPhone, and refers you to the correct app.

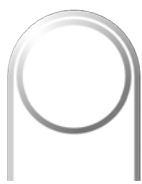

CESeasy app "access"



If the scan does not work, please open the following link on your smartphone. The link is also able to detect whether you are using an Android phone or iPhone, and refers you to the correct app.

<https://ces.qr1.at/CESeasyApp>

Smartphone prerequisites:

- iOS (iOS 9.2 or higher) or Android (Android 4.4 or higher)
 - If you use an iPhone: iPhone 4S or newer models
- Bluetooth 4.0 or higher
- suitable for Bluetooth Low Energy

Location transmission

To enable the CESeasy app to connect to the lock, the location transmission must be activated. This applies to both the settings of **the app itself** (CESeasy app must be allowed to share the

location) and the location transmission **of your smartphone** (location transmission must be activated for the smartphone).

-  If you use an Android smartphone, you may have to set the location transmission once manually in the settings of the CESeasy app after it has been installed.

12.2 How to use it with a remote control



You can operate the door controller with a CESeasy remote control. Press a button of the remote control not too far away from the door controller. The lock owner defines the functions assigned to the buttons of the remote control.

-  For details, please refer to the [manual for the CESeasy remote control](#).

Remote control range

The remote control range depends on various factors:

- The lock environment (building materials of doors, walls, etc.)
- The remote control environment (the way it is held, if it is used inside or outside, etc.)
- The surrounding environment between lock and remote control (doors and walls between them, further radio signals in the surroundings which could influence the communication, etc.)

13 Technical data

13.1 Equipment features

CESeasy door controller	
Article number	Door controller: 347101V Starter set: EASY-DCS (door controller, 1 remote control, 5 digital keys, "lock management" function (5 years))
Dimensions	115 mm x 72 mm x 27 mm
Material	ABS, black
Power supply	
Batteries	4 x AA alkaline batteries
Power input (screw connector)	8 ... 15 VAC / 100 mA or 12 ... 24 VDC / 100 mA / stabilised Average power consumption: below 5 mA at 12 VDC
Optional power supply unit	Article number 347123
Inputs and outputs	
Sensor input (screw connector)	Input for an optional door contact (347129V). Max. cable length: 3 m
Relay output (screw connector)	Relay switching output (NO / NC) Max. 30 VDC / 1.5 A (ohmic load)
Further inputs and outputs	Available via the CESeasy communication module
RF-Transceiver	
RF-Transceiver	868 MHz, for remote controls and the communication module
Bluetooth LE transceiver	2.4 GHz, to communicate with mobile phones
Encryption	AES128
Memory / capacity	
Number of digital keys	600 access group (1 access group = max. 65,000 employee keys, or 1 digital key, or 1 remote control)
Encryption	AES128
Service life	
Service life	Max. 500.000 operations (at 20°C), depending on the contact load
Battery service life	Approx. 100.000 operations within 1 year (at 20°C)
Environment	
Device environment	The product is intended for indoor use only
Operating temperature	0 ... + 50°C
Humidity during operation	5 ... 90%, non-condensing
Unsuitable climates	Do not use in corrosive environments (chlorine, ammonia, lime water)
Tests and certificates	
CE label	NEN EN 300330-02, NEN EN 301489-03
Control and operation	
Mobile phone	Compatible Apple device with BLE and iOS 9.2 or higher Compatible* Android device with BLE and Android 4.4 or higher

* Due to the vast number of different Android phones and versions testing the compatibility of a particular Android device is recommended.

13.2 Dimensions

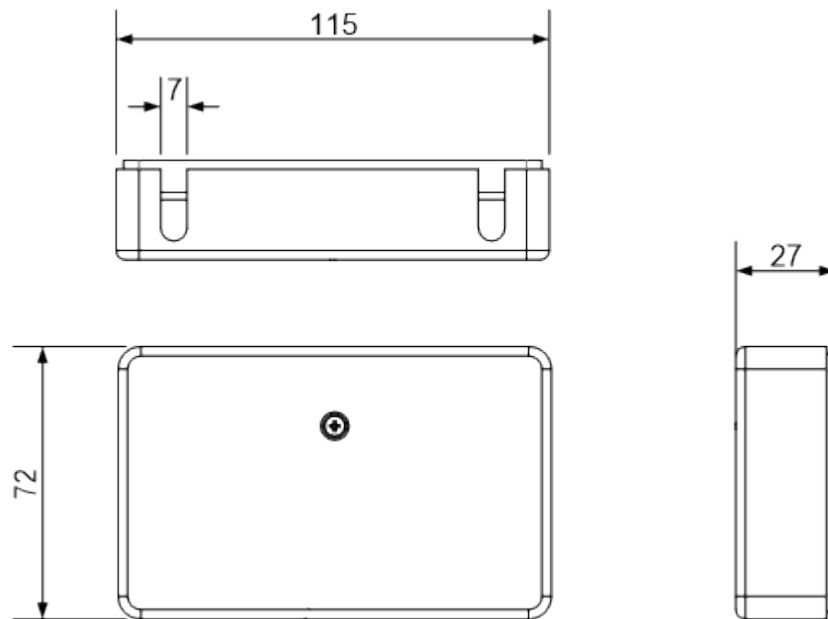

14 Optional accessories

14.1 Door contact

The door contact transmits the information “door is locked” or “door is open” to the lock. This information can be used for motor cylinders and door controllers.

If you connect a door contact to your door, you can define if a door is to be controlled depending on whether it is open or closed. It means that:

- The door is activated until it has opened
- The door is activated until it is closed

Both additional controls can be limited in time (please refer to section "[Configuration](#)" on page 20 for information on how to configure door contacts).

A suitable door contact is available via CES (article number:347129V).

14.1.1 How to connect a door contact

 The door contact you use must have a potential-free contact (normally open or normally closed).

 Always follow the manufacturer’s instructions of the door contact you want to connect to the door controller.

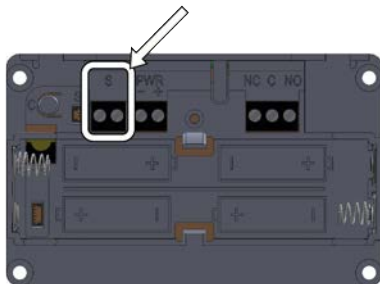

 The port intended for connection of the door contact is located at the screw terminal marked “S”.

14.2 Power supply unit

 To ensure that the door controller keeps working also in the event of a power failure, keep using batteries in addition to the power supply unit. The batteries are not used as long as the external power supply is used.

Requirements of the power supply unit:

- 12 - 24VDC stabilised
- Current of at least 100mA

A suitable power supply unit is available via CES.

Power supply unit for the door controller: 347123

14.2.1 How to connect the power supply unit

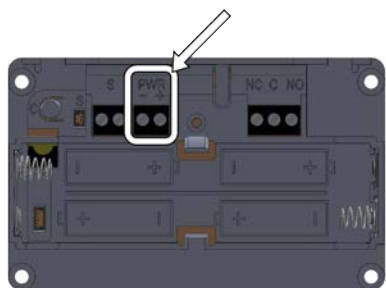

 The port intended for connection of the power supply unit is located at the screw terminal marked “PWR”.

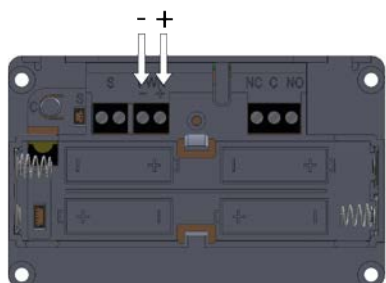

 Make sure to connect the power supply unit correctly to the positive and negative terminal.

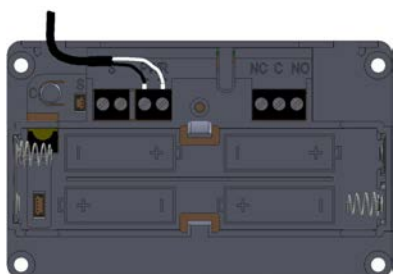

 Run the connecting cables through the recess of the case towards the outside.

15 Disposal

15.1 Notes on disposal

Device

In accordance with the Waste Electrical and Electronic Equipment recycling (WEEE) Regulations, every consumer has a duty to dispose of old electronic/electrical appliances safely and separately from household waste. It is forbidden to dispose of electronic devices in the household waste. You can bring old devices free of charge to the local (council's) collection points. Or you can send the device to C.Ed. Schulte GmbH Zylinderschlossfabrik, Velbert/Germany. Please make sure correct postage is paid for the return.



The symbol with the crossed-out dust bin signifies old electrical appliances must not be disposed of as household waste.

Electronic devices contain many different substances and materials. If old electronic devices are not disposed of appropriately, the contaminants contained in them can lead to health and environmental hazards. In addition, appropriate disposal allows recovery and re-use of recyclable materials, which is a substantial contribution to maintaining natural resources.

Batteries

In accordance with the Waste Batteries and Accumulators Regulations 2009, every consumer has a duty to return used and empty batteries. It is illegal to dispose of them in the household waste. You may bring all batteries free-of-charge to any local (council's) collection point that is part of the waste battery collection scheme. You can also send used batteries that were delivered by CES back to C.Ed. Schulte GmbH Zylinderschlossfabrik, Velbert/Germany. Please make sure correct postage is paid for the return.

Used batteries may contain contaminants or heavy metals which can pose a health and environmental hazard. Batteries are recycled, as they contain important raw materials like iron, zinc, manganese, or nickel.



The symbol with the crossed-out dust bin signifies that batteries and rechargeable batteries must not be disposed of as household waste. Beneath the symbol you may also find the chemical designation of the substances contained, e.g.:

- (Pb) lead
- (Cd) cadmium
- (Hg) mercury

Collection points for batteries and rechargeable batteries are identified by a variety of symbols.

Package

Packaging of the components is made from environmentally friendly, reusable materials. In detail, these are:

- Outside packaging and inlays from cardboard
- Inlays and protective foils from Polyethylene (PE)



Please dispose of the packaging in an environmentally friendly way through waste separation streams.

16 Index

1

100 employees (extension function) 31

5

5 additional keys (extension function) 30

A

Accessories 36

App 20

Assembly 12

B

Batteries 17

 Safety instructions 7

Battery consumption 17

Battery replacement 19

Building management (extension function) 30

C

CESeasy app 20

CESeasy web platform 29

Connection

 Door contact 36

Power supply unit 37

Relay 15

Control 26

Coupling 21

Coupling button 21

D

Declaration of conformity 6

Dimensions 35

Door contact 36

E

EU Declaration of conformity 6

Extension functions 29

F

Firmware update 28

Flyback diode 15

Functions (extension functions) 29

K

Key to organisation 30

L

Lock management (extension function) 29

O

Operation via smartphone 32

Organisation (extension function) 31

P

Power supply unit 37

R

Registration card 10

Relay 15

Remote control 33

S

Safety instructions 6

Scope of delivery 10

U

Use with a remote control 33

W

Web platform 29



C. Ed. Schulte GmbH

Zylinderschlossfabrik

Friedrichstraße 243

D-42551 Velbert

☎ +49 2051 204 0

☎ +49 2051 204 229

@ info@ces.eu

CESnederland B.V.

Lage Brink 9

NL-7317 BD Apeldoorn

☎ +31 55-52 66 89 0

☎ +31 55-52 66 89 9

@ infonl@ces.eu

CESfrance SARL

8 Impasse Charles Petit

F-75011 Paris

☎ +33 1 44 87 07 56

☎ +33 1 43 07 35 78

@ infofr@ces.eu

CESitalia srl

V. d. vecchie Fondamenta, 4

Straße d. A. Gründungen 4

I-39044 Egna / Neumarkt (BZ)

☎ +39 0471 812 294

☎ +39 0471 812 294

@ info@it.ces.eu

CESrom srl.

Str. Metalurgistilor 3 D

RO-550137 Sibiu

☎ +40 269-206 00 2

☎ +40 269-206 00 5

@ info@ro.ces.eu

United Kingdom

CES Security Solutions Ltd.

Unit 4 Kendon Business Park

Maritime Close, Medway City Estate

Rochester, Kent ME2 4JF

☎ +44 1 634 713 369

☎ +44 1 634786833

@ info@uk.ces.eu

Middle East

A.G.P Advanced German Products LLC

PO Box 102761

UAE Dubai

☎ +971 4 885 7050

☎ +971 4 369 7051

☎ +971 4 390 8935

@ info@agp-dubai.com

Austria

César A. Cárcamo

Büro: Wiener Bundesstrasse 33

A-4050 Traun

☎ +43 660-73 20 311

☎ +43 732-21 00 22 2681

@ office@ces.at

Belgium

LockingSystems

Guy Lambrechts

Van Haftenlaan 10

BE-2950 Kapellen

☎ +32 497 946267

@ guy.lambrechts@ces.eu

Spain

Benidorm Locks S.L.

Av. Marina Baixa s / n

Partida Torrent

ES-03530 La Nucia, Alicante

☎ +34 96 689 79 79

☎ +34 96 689 79 78

@ info@benidormlocks.com