

# CESeasy

## Communication module



### Assembly and Operating Manual

 English

Version VB

BRO2280-2

## Contents

<b>1 About this manual</b> .....	<b>4</b>
1.1 Design characteristics .....	4
1.2 Target group of this manual .....	4
<b>2 Manufacturer's information</b> .....	<b>5</b>
2.1 Manufacturer and service .....	5
2.2 Manufacturer's warranty .....	5
<b>3 For your safety</b> .....	<b>6</b>
3.1 EU Declaration of conformity .....	6
3.2 Intended use .....	6
3.3 Basic safety instructions .....	6
3.4 Notes on dealing with batteries .....	7
<b>4 CESeasy communication module</b> .....	<b>9</b>
4.1 About communication modules .....	9
4.2 Scope of application .....	9
<b>5 Scope of delivery</b> .....	<b>10</b>
<b>6 Assembly</b> .....	<b>11</b>
<b>7 Connections</b> .....	<b>14</b>
7.1 How to connect the power supply unit .....	14
7.2 How to connect the inputs and outputs .....	15
<b>8 Batteries</b> .....	<b>21</b>
8.1 Required batteries .....	21
8.2 Battery consumption .....	21
8.3 Battery warnings .....	21
8.4 Check the battery status .....	22
8.5 How to insert and change batteries .....	23
8.6 Battery disposal .....	23
<b>9 How to couple a lock</b> .....	<b>24</b>

---

9.1 Coupling .....	24
9.2 Decoupling .....	26
9.3 Coupling to a new lock .....	26
<b>10 Administration .....</b>	<b>27</b>
10.1 Firmware .....	27
10.2 Reset of the communication module .....	27
<b>11 Operation .....</b>	<b>29</b>
11.1 Privacy mode .....	29
11.2 Night locking mode (only motor cylinders) .....	29
<b>12 Technical data .....</b>	<b>31</b>
12.1 Equipment features .....	31
12.2 Dimensions .....	32
<b>13 Disposal .....</b>	<b>33</b>
13.1 Notes on disposal .....	33
<b>14 Index .....</b>	<b>35</b>

## 1 About this manual



These assembly and operating instructions, hereinafter referred to as the “manual”, will help you with the assembly and in a proper, safe, and beneficial use of the CESeasy products acquired.

Anyone who assembles, administers, maintains, or disposes of CESeasy products, must have read and understood the complete contents of this manual.

If you do not understand the functions of the CESeasy products, please contact your CES partner for further information.

-  Always use the latest version of this manual. The version number of this manual is shown on the cover page. You can get the latest version free of charge from [www.ces.eu](http://www.ces.eu)

### 1.1 Design characteristics

-  Refers to other documents.
-  Marks additional information and tips.
-  Marks warnings in step-by-step instructions and specially important information.

### 1.2 Target group of this manual

This manual is intended for

- Trained service and assembly personnel
- Maintenance personnel
- Operators

The necessary expertise regarding the intended use of the product is presumed for the use of this manual.

The necessary product training is conducted by your CES partner. If this has not yet taken place, please contact your CES partner to get the product training.

## 2 Manufacturer's information

### 2.1 Manufacturer and service

C.Ed. Schulte GmbH

Zylinderschlossfabrik

Friedrichstr. 243

42551 Velbert

Tel: +49 (0) 2051-204-0

Fax: +49 (0) 2051-204-229

[www.ces.eu](http://www.ces.eu)

### 2.2 Manufacturer's warranty

The following damage is not covered by the manufacturer's warranty:

- Damage to the exterior mechanical parts as well as subsequent damage arising from normal wear and tear.
- Damage caused by external events or influences
- Damage caused by deficient assembly
- Damage caused by deficient maintenance
- Damage caused by false operation
- Damage caused by overvoltage
- Damage caused by fire, water or smoke

All technical data and features are subject to change without prior notice. All information and data contained in this document is subject to change without prior notice. Without express written approval from C.Ed. Schulte GmbH Zylinderschlossfabrik, no part of this document may be copied or transmitted for any purposes whatsoever.

© 2018 C.Ed. Schulte GmbH Zylinderschlossfabrik, Velbert/Germany

VB

BRO2280-2

## 3 For your safety

### 3.1 EU Declaration of conformity

You can find the EU Declaration of conformity on the Internet at [www.ces.eu](http://www.ces.eu).

### 3.2 Intended use

CESeasy products are intended to control access at doors. They are exclusively intended for this purpose and may only be used for this. They may never be altered in any way without written permission from C.Ed. Schulte GmbH Zylinderschlossfabrik.

All other uses are regarded as improper use and may lead to material damage or even personal injuries. C.Ed. Schulte GmbH Zylinderschlossfabrik assumes no liability for damage caused by improper use.

### 3.3 Basic safety instructions

CESeasy products have been built with state-of-the-art technology and established safety regulations. Nevertheless, their use may constitute function-related hazards for the user or third parties and may impair the handle set and other material assets.

Please observe all warnings and notices in this manual while assembling, configuring and using CESeasy products.

#### 3.3.1 Life-threatening danger

- CESeasy products have not been developed, tested and/or approved for access in life-threatening situations. Do not use CESeasy products on fire doors or panic doors.
- CESeasy products must be suitable for your door system. If you are in doubt, please contact the manufacturer of the door or lock to check suitability.
- All components which are required for a complete installation at your door must be CE-compliant. Please check before installation whether all components used are CE-compliant.

#### 3.3.2 Danger of personal injury

##### Danger of explosion

- Live parts may cause explosion. Do not use parts in potentially explosive areas.

### 3.3.3 Danger of damage to material assets

#### Transportation

- Do not drop the device on the floor, on hard surfaces or objects.

#### Assembly

- The device contains highly sensitive electronic components, which can be damaged or destroyed through electrostatic charges. Therefore, do not assemble the handle set in areas affected by electrostatic charge.
- For assembly and dismantling, use the tools indicated in the "Assembly" section only.
- Only use a dry or protected or indoors place for device installation.

#### Operation

- Protect the electronic components against water and other fluids.

#### Maintenance

- Always have repairs performed by qualified personnel.
- Use only the accessories and spare parts recommended by CES.

#### Danger through climatic influences

- Do not use the device in corrosive atmosphere (chlorine, ammonia, lime water)
- Do not use the device in areas with high dust formation.
- Do not use the device near heat sources.

Please observe the maximum permissible temperatures and the information on air humidity in the section "Technical Data".

## 3.4 Notes on dealing with batteries

- Always insert new batteries only. Never use old and new batteries together.
- Before inserting the batteries, check whether the contacts in the device and on the batteries are clean. Otherwise, clean them. Do not touch the contacts after the cleaning process.
- When inserting the batteries, ensure that the polarity is correct (+/-).
- Never try to recharge the batteries. There is a risk of explosion!
- Do not short-circuit the batteries.
- Store batteries in a cool and dry place. Direct heat may damage the batteries. Therefore, do not expose battery-operated devices to any strong heat source, and do not throw the batteries into fire.

- If you do not use devices for a longer time, take out the batteries.
- Remove leaking batteries immediately from the device. Clean the contacts before inserting new batteries. There is danger of injury from battery acid.
- Remove the empty batteries from the device.
- Please take note of the information on battery disposal (see "[Disposal](#)" on page 33).



## 4 CESeasy communication module

### 4.1 About communication modules



A CESeasy communication module allows you to control CESeasy motor cylinders and CESeasy door controllers with devices from other manufacturers.

-  A communication module can control both a motor cylinder and a door controller. Therefore, the term “lock” is used as an umbrella term. This can refer to either a motor cylinder or a door controller.

The communication module has several inputs through which orders are forwarded to the lock. There are additional outputs which reflect the lock status. The communication module and the lock communicate wirelessly.

### 4.2 Scope of application

Due to the available inputs and outputs and the functions which are linked to them, the communication module can be used in a very versatile manner. The communication module is to be used together with a CESeasy motor cylinder or a CESeasy door controller.

-  CESeasy products have not been developed, tested and/or approved for access to escape and emergency routes. Do not use CESeasy products on fire doors or panic doors.
-  The device must be installed in a dry and protected place in the building.

## 5 Scope of delivery

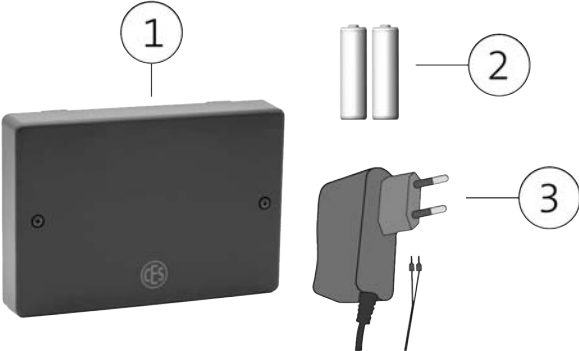

---

1	1 Communication module
2	2 Batteries
3	1 Power supply unit

---

## 6 Assembly

### Distance between the communication module and the lock

-  A communication module can control both a motor cylinder and a door controller. Therefore, the term “lock” is used as an umbrella term. This can refer to either a motor cylinder or a door controller.

The maximum distance for the wireless communication between the communication module and the lock linked to it strongly depends on the environment, the building materials used, and other items found in the proximity. These factors can absorb or reflect the radio signal, which is why it is not possible to make a general statement about the maximum distance. In most cases, a distance of up to 10m within a building will be possible. You have to find out the maximum distance for your situation.

### Notes on the installation

- The device has to be fixed to a level surface.
- The device must be installed in a dry and protected place in the building.

### Tools required

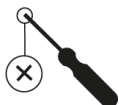
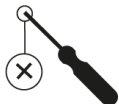
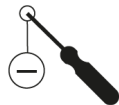
Tool		Required for
	PH1 Phillips screwdriver	Open the cover
	PZ2 Phillips screwdriver	Wall assembly
	0.5 mm x 3 mm slot-head screwdriver	How to connect the ports

### Installation of the communication module



1. Use the PH1 screw driver to loosen the screws in the cover of the communication module, and pull off the cover.

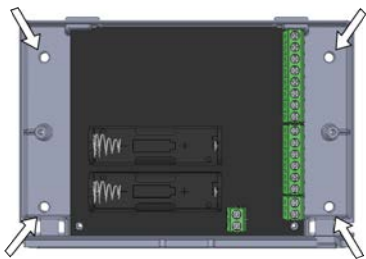

2. The communication module case contains four assembly openings. Attach the communication module with at least two 4mm countersunk head screws to a level surface.

 The length of the screws depends on the surface.

 Depending on the surface you may have to use suitable dowels.

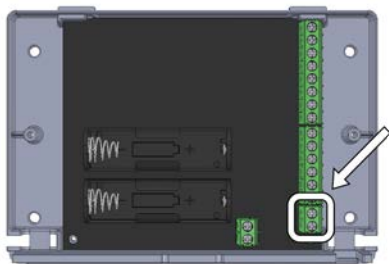

3. Connect the power supply unit (see ["How to connect the power supply unit"](#) on page 14).

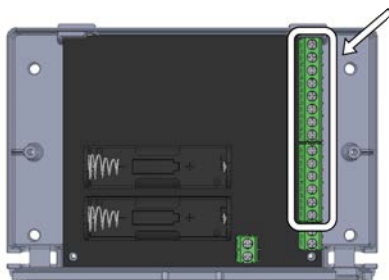

4. Connect the inputs and outputs (see ["How to connect the inputs and outputs"](#) on page 15).



5. Insert the batteries (for details about batteries, please refer to section "Batteries" on page 21.)

 Please ensure that the batteries are inserted according to the labelling in the battery compartment which indicates the correct polarity.

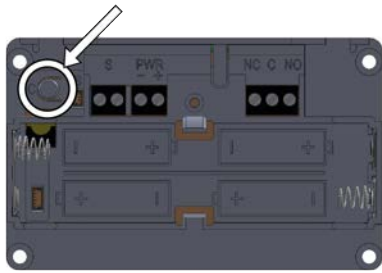

6. Link the communication module to your lock (see "How to couple a lock" on page 24).

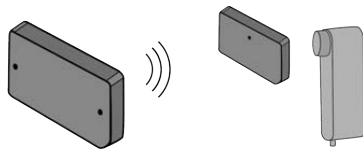

7. Check if the communication module is working correctly.





8. Screw the cover back onto the case.

*The communication module is now completely mounted and ready for use.*

## 7 Connections

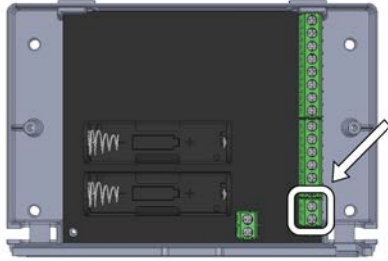
### 7.1 How to connect the power supply unit



-  The port intended for connection of the power supply unit is located at the screw terminal marked "12VCD" and "GND".

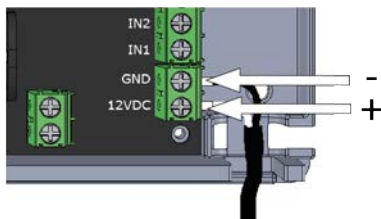

-  Make sure to connect the power supply unit correctly to the positive and negative terminal.

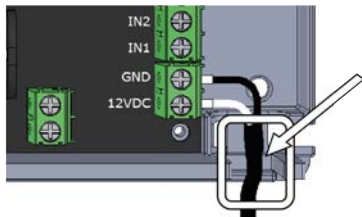

-  Run the connecting cables through the recess of the case towards the outside.

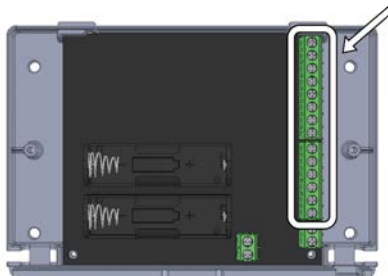

-  Before connecting the power supply unit to the power source, connect the inputs and outputs first.

## 7.2 How to connect the inputs and outputs

 Please always note the instructions of third-party manufacturers when you connect their devices.

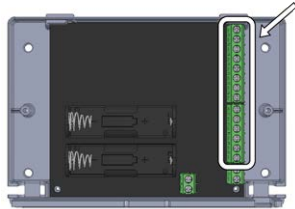

The communication module is equipped with 4 inputs and 6 outputs which can be connected by means of the screw terminals on the right side of the circuit board.

### 7.2.1 Inputs



The communication module is equipped with 4 inputs labelled IN1 to IN4.

#### Functions of the inputs

Input	Function	Reaction upon activation	Reaction upon deactivation	Remarks
IN1	Open	The order "Open" is sent to the coupled lock	No reaction	If IN1 and IN2 are bridged so that both can be switched simultaneously, they react as follows:  - If both inputs are activated, the order "Open" is sent to the coupled lock  - If both inputs are deactivated, the order "Close" is sent to the coupled lock
IN2	Close	The order "Close" is sent to the coupled lock	No reaction	
IN3	Privacy mode	The order "Privacy mode ON" is sent to the coupled lock	The order "Privacy mode OFF" is sent to the coupled lock	Please take note of the information on " <a href="#">Privacy mode</a> " on page 29.
IN4	Night locking mode	The order "Night locking mode ON" is sent to the coupled lock	The order "Night locking mode OFF" is sent to the coupled lock	The night locking mode is only relevant for motor cylinders.  Please take note of the information on " <a href="#">Night locking mode (only motor cylinders)</a> " on page 29.

### Information on the activation and deactivation of the inputs

The inputs are digital inputs with a high input resistance. The inputs are low-active and are fitted with an internal pull-up resistor. Inputs are connected between INx and GND by means of a potential-free contact.

**Example:** The moment input 1 is activated, the order “Open” is sent to the coupled lock. If input 1 afterwards still remains activated and e.g. a “Close” order is sent by the CESeasy app, the lock will carry out the “Close” order but will not react to input 1 anymore although it is still active. Only if input 1 is deactivated first and then activated again, another “open” order will be sent.

The input is either active or inactive if the status changes and the input voltage is between the following values:

Status	U <sub>in</sub> (min)	U <sub>in</sub> (max)	Contact between INx and GND
Active	0 VDC	0.5 VDC	closed
Inactive	2.5 VDC	12 VDC	open



**Examples which show how the inputs can be connected**

**Example 1 - Potential-free contact**

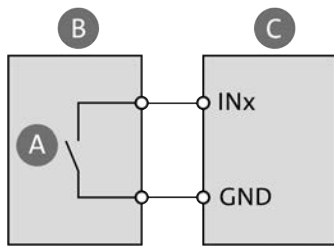

Between INx and GND a potential-free contact is connected (e.g. a switch or a relay). As soon as the contact closes, INx is considered to be 'active'.

- A: Potential-free contact
- B: Device with an output
- C: Communication module

**Example 2 - Open-collector output**

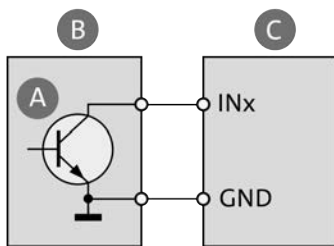

A device with an open-collector output is connected to INx of the communication module. As soon as the output is activated, INx is considered to be 'active'.

- A: Open-collector output
- B: Device with an output
- C: Communication module

## 7.2.2 Outputs

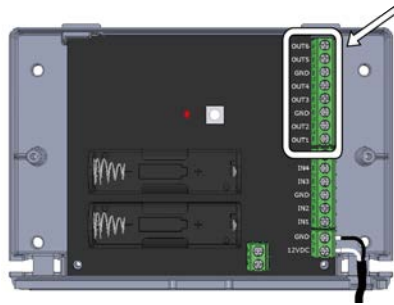

The communication module is equipped with 6 outputs labelled OUT1 to OUT6.

### Functions of the outputs

Output	Function	Activated by	Deactivated by	Remarks
OUT1	Batteries nearly empty	Is activated if the batteries of the communication module of the coupled lock are nearly empty.	Is deactivated if the battery voltage of the communication module is high again and the "Batteries nearly empty" message of the coupled lock has been reset.	
OUT2	Communications error	Is activated if it is not possible to establish wireless communication with the coupled lock.	Is deactivated as soon as wireless communication with the coupled lock has been re-established.	<p>The output status is updated by controlling the communication with the coupled lock:</p> <ul style="list-style-type: none"> <li>- Whenever orders are exchanged between the communication module and the coupled lock.</li> <li>- The connection is checked by means of a polling procedure once per minute.</li> </ul>
OUT3	Privacy mode active	Is activated if the privacy mode is activated.	Is deactivated if the privacy mode is deactivated.	Please take note of the information on " <a href="#">Privacy mode</a> " on page 29.
OUT4	Night locking mode active	Is activated if the night locking mode is activated.	Is deactivated if the night locking mode is deactivated.	<p>The night locking mode is only relevant for motor cylinders.</p> <p>Please take note of the information on "<a href="#">Night locking mode (only motor cylinders)</a>" on page 29.</p>
OUT5	Door unlocked	Is activated if the coupled lock unlocks the door.	Is deactivated when "Open" has been completed. This depends on the lock settings (e.g. opening times	<p>The locks have to meet the following conditions:</p> <ul style="list-style-type: none"> <li>- Motor cylinder: latch and</li> </ul>

Output	Function	Activated by	Deactivated by	Remarks
			for the motor cylinder, or the reaction time limit for controlling the door controller).	deadbolt are drawn in - Door controller: as long as the relay is activated (status "Open")
OUT6	Door status	Is activated if the door contact of the coupled lock signals "Door closed".	Is deactivated if the door contact of the coupled lock signals "Door open".	To use this output, a door contact is required for the lock.

**Information on the outputs**

The outputs of the communication module are open-collector outputs which can switch max. 150mA. The maximum voltage is 28V.

An open-collector output is not a potential-free contact. The output consists of a transistor (semiconductor) which depends on the status of the output (conductive or non-conductive). If it is conductive (output is active), a connection to GND is established. It means that:

1. Either the devices to be connected have to be supplied by means of an external power supply, and 'GND' or '-' of the power supply have to be connected to 'GND' of the communication module
2. Or the devices to be connected must be equipped with an input which is low-active and has a high input resistance.

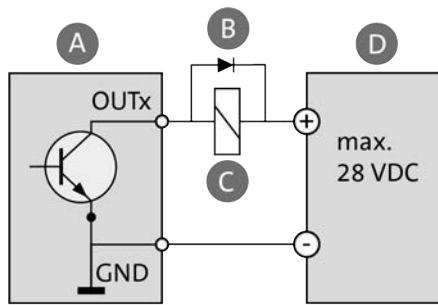
**Situation 1: Circuit with an inductive load**

- A: Communication module  
 B: Flyback diode  
 C: Relay  
 D: External power supply (DC)

A relay is connected to OUTx. The relay is connected to an external power source.

The fact that a relay is an inductive load means that the relay coil has to be equipped with a flyback diode.

 When you want to switch **inductive loads** like magnets, relays, coils, etc. **always use a flyback diode** directly on the load. The device may be damaged if no flyback diode has been used, or if it was connected falsely!

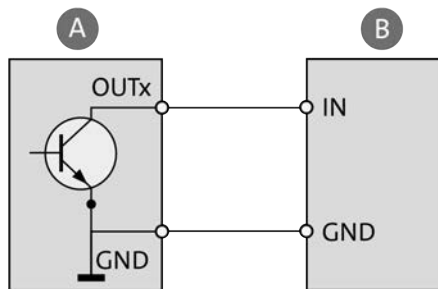
**Situation 2: Circuit with an input**

- A: Communication module  
 B: Device with an input

OUTx is directly connected to the input of another device. The input has to meet the following conditions:

- Input current max. 150mA
- Voltage, measured between IN and GND, max. 28V
- Internal pull-up resistor, or an external pull-up resistor can be connected
- The entry is low-active (if not, the device must be able to invert its status)

## 8 Batteries

### 8.1 Required batteries

You need 2 AA alkaline batteries.

 These batteries serve as an emergency power supply in the event of a power outage.

### 8.2 Battery consumption

If the power supply unit fails, the communication module can continue to work for some days with a new set of batteries.

### 8.3 Battery warnings

If the batteries of the communication module are nearly empty, the communication module activates output 1 (see "Outputs" on page 18).

 Output 1 is also activated if the batteries of the coupled lock are nearly empty.

### 8.4 Check the battery status

You can check the battery status of the communication module when the cover is open (e.g. during installation or maintenance).

To be able to check the battery status, the following prerequisites need to be met:

- The communication module has to be switched on.
- Firmware has to be installed on the communication module (see "[Firmware](#)" on page 27).

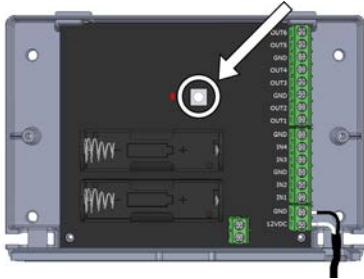

**1. Press the coupling button.**

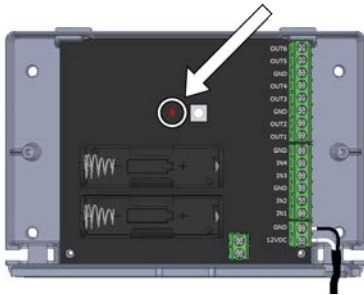

*Now the red LED next to the coupling button indicates the battery status:*

It is permanently illuminated	Batteries are full
It flashes	Batteries are nearly empty. Insert new batteries.
It is not illuminated	Batteries are empty, or there are no batteries. Insert new batteries.

## 8.5 How to insert and change batteries

### Tools required

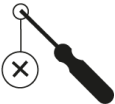
Tool		Required for
	PH1 Phillips screwdriver	Open the cover

### How to insert and change batteries



1. Use the PH1 screw driver to loosen the screws in the cover of the communication module, and pull off the cover.

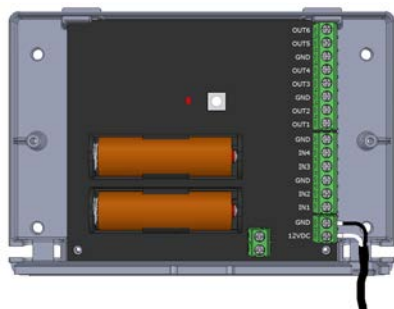

2. If necessary, take out the two empty batteries. Insert the two new batteries.

 Please ensure that the batteries are inserted according to the labelling in the battery compartment which indicates the correct polarity.



3. Screw the cover back onto the case.  
*The batteries are now inserted or have been changed.*

## 8.6 Battery disposal

See "Disposal" on page 33.

## 9 How to couple a lock



### 9.1 Coupling

-  A communication module can control both a motor cylinder and a door controller. Therefore, the term “lock” is used as an umbrella term. This can refer to either a motor cylinder or a door controller.

To be able to control your lock via the communication module, you have to connect it to the communication module (= to couple it). Having coupled your lock, the communication module enables you to send orders to your lock using your third party device. The device transmits the lock status (e.g. open, closed, or batteries nearly empty) to the communication module, which then can be displayed by our third party device.

-  Only *one* lock (one motor cylinder or door controller) can be coupled to a communication module at the same time.

#### Prerequisites for coupling:

- The latest firmware version is installed on your lock.
  -  For details, please refer to the [CESeasy manual for motor cylinders](#).
- Or
  -  For details, please refer to the [CESeasy door controller manual](#).

#### Coupling between communication module and lock

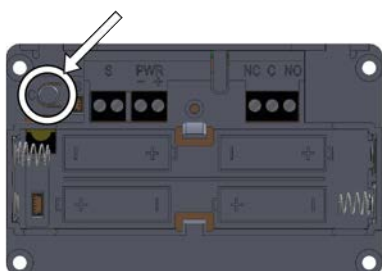

##### 1. To couple a door controller:

Press the coupling button of the door controller for approx. 1 second.

-  For details, please refer to the [CESeasy door controller manual](#).

*Now, the door controller periodically emits an acoustic signal.*



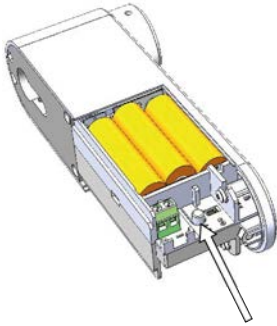

**1. To couple a motor cylinder:**

Press the coupling button of the motor cylinder for approx. 1 second.

 For details, please refer to the [CESeasy manual for motor cylinders](#).

*Now, the motor cylinder periodically emits an acoustic signal.*

 Now, do **not** couple the door controller or the motor cylinder to the CESeasy app, and do **not** start a manual firmware update. Otherwise, no device can be coupled to the communication module.

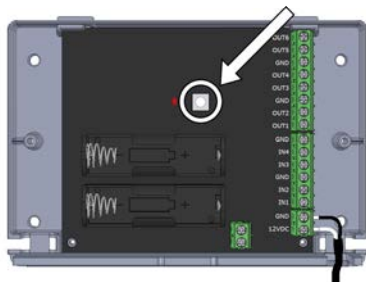

**2. Press the coupling button of the communication module for approx. 1 second.**

*If the communication module was able to couple to the lock, the lock will emit a long acoustic confirmation signal.*

 As soon as the coupling has been accomplished, the firmware required for the communication module will be transmitted from the lock to the communication module. This process lasts about 10 seconds.

## 9.2 Decoupling

Coupling consists of connections between two devices:

- From the communication module to the lock, and
- from the lock to the communication module.

For this reason, decoupling has to occur for both devices:

For the lock

By means of the configuration menu



For details, please refer to the [CESeasy manual for motor cylinders](#).

Or



For details, please refer to the [CESeasy door controller manual](#).

---

For the  
communication  
module

By resetting the communication module (see "[Reset of the communication module](#)"  
on the facing page)

---

## 9.3 Coupling to a new lock

You can couple the communication module to a second lock without having to end the coupling connection to the communication module beforehand (= reset). The old connection information is automatically overwritten.



Do not forget to delete the coupling in the first lock. Otherwise, the lock will permanently and unsuccessfully try to connect to the communication module.

## 10 Administration

### 10.1 Firmware

-  A communication module can control both a motor cylinder and a door controller. Therefore, the term “lock” is used as an umbrella term. This can refer to either a motor cylinder or a door controller.

The lock which is coupled to the communication module controls the firmware version of the communication module. If the coupled lock detects the fact that new or different firmware is required for the communication module, it transmits the new or different firmware to the communication module. This ensures that the firmware in the communication module is always compatible with the firmware in the lock.

#### Firmware updates

- The firmware is always automatically updated after a lock has been coupled to the module (see "[How to couple a lock](#)" on page 24). Consequently, the firmware in the communication module is always compatible with the firmware in the lock.
- If required, the firmware is updated after a firmware update has been carried out in the coupled lock.

It is not possible to carry out a manual firmware update for a communication module.

### 10.2 Reset of the communication module

You can delete the communication module data completely. It means that:

- The coupled lock is deleted from the memory of the communication module
- The firmware is deleted from the communication module

## Reset of the communication module

1. Switch the communication module off completely by disconnecting the power supply unit and taking out the batteries.

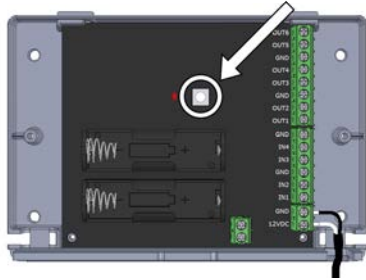

2. Keep the coupling button pressed.

3. While you keep the coupling button pressed, switch the communication module back on by restoring the power supply with the power supply unit, or by reinserting the batteries.

4. Release the coupling button.

*The coupled lock and the firmware have now been deleted from the communication module.*

-  Due to the fact that the communication module does not have any firmware, the battery status cannot be checked (see "[Check the battery status](#)" on page 22).

## 11 Operation

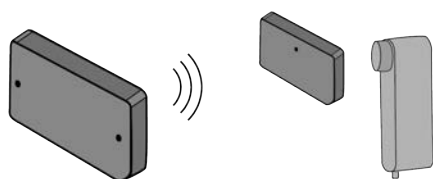

With a communication module you can control a CESeasy motor cylinder or a CESeasy door controller. The way you issue orders depends on the third party device you have connected to the communication module.

Next to the standard functions “Open” and “Close”, the communication module allows you to use the following additional functions:

- Privacy mode (for the motor cylinder and door controllers)
- Night locking mode (only motor cylinders)

### 11.1 Privacy mode

When the privacy mode is activated, the employees of an organisation cannot open the lock. The lock can be opened only with keys which you have issued directly to someone.

**Example:** You have issued a key to a nursing service, which passes on the key to several employees. You have issued two additional keys to your children. When you activate the privacy mode, the employees of the nursing service can no longer open your lock. However, your children can still open the lock, because they have received the key directly from you.



 When in privacy mode, the lock can still be opened manually or via remote control.

### 11.2 Night locking mode (only motor cylinders)

If in night locking mode, the motor cylinder locks the door, which then no longer can be mechanically opened. If someone tries to turn the rotary knob in the opening direction, the motor cylinder exerts some force turning it in the closing direction. The night locking mode is a break-in resistance property intended e.g. to prevent someone from turning the rotary knob of the motor cylinder from the outside through the mail slot.

 The night locking mode is deactivated when the lock is opened by remote control or the CESeasy app.

 To be able to open a door which is in night locking mode, you must have a remote control or the CESeasy app. In an emergency, this could lead to life-threatening situations!

-  Before you activate the night locking mode, be sure to note all requirements concerning escape routes and fire protection (e.g. certain doors must not be locked).
  
-  When in night locking mode, the motor prevents the knob from being manually turned by exerting force in the opposite direction. This uses a lot of battery energy, which is why they may empty more quickly when in night locking mode.

## 12 Technical data

### 12.1 Equipment features

<b>CESeasy communication module</b>	
Article number	347102V
Dimensions	152 mm x 104 mm x 28 mm
Material	ABS, black
<b>Power supply</b>	
Power input (screw connector)	5 ... 12 VDC / 100 mA / stabilised
Power supply unit	A suitable plug-in power supply (Euro plug) is included in delivery
Emergency power supply	2 x AA alkaline or lithium batteries
<b>Inputs and outputs</b>	
Inputs (screw connectors)	4 inputs with standard assignment
Outputs (screw connectors)	6 outputs with standard assignment Maximum load 28V / 150 mA
<b>RF-Transceiver</b>	
RF-Transceiver	868 MHz for wireless communication with compatible CESeasy devices
Encryption	AES128
<b>Service life</b>	
Battery service life without power supply unit	Max. 4 days at 20°C, low temperatures shorten the battery life
<b>Environment</b>	
Device environment	The product is intended for indoor use only
Operating temperature	0 ... + 50°C
Humidity during operation	5 ... 90%, non-condensing
Unsuitable climates	Do not use in corrosive environments (chlorine, ammonia, lime water)
<b>Tests and certificates</b>	
CE label	NEN EN 300330-02, NEN EN 301489-03

**12.2 Dimensions**

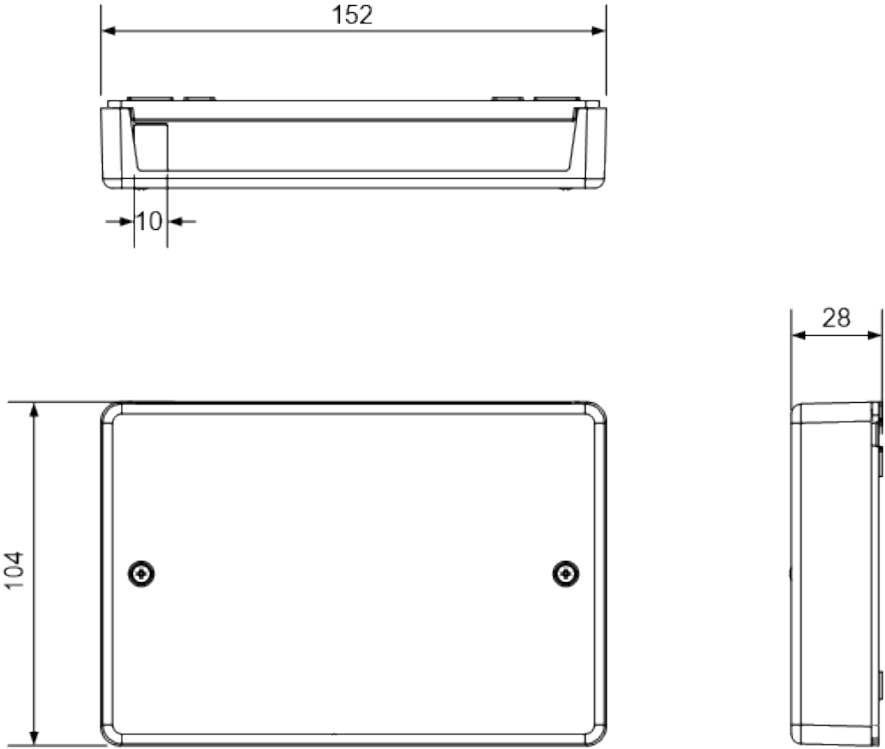



## 13 Disposal

### 13.1 Notes on disposal

#### Device

In accordance with the Waste Electrical and Electronic Equipment recycling (WEEE) Regulations, every consumer has a duty to dispose of old electronic/electrical appliances safely and separately from household waste. It is forbidden to dispose of electronic devices in the household waste. You can bring old devices free of charge to the local (council's) collection points. Or you can send the device to C.Ed. Schulte GmbH Zylinderschlossfabrik, Velbert/Germany. Please make sure correct postage is paid for the return.



The symbol with the crossed-out dust bin signifies old electrical appliances must not be disposed of as household waste.

Electronic devices contain many different substances and materials. If old electronic devices are not disposed of appropriately, the contaminants contained in them can lead to health and environmental hazards. In addition, appropriate disposal allows recovery and re-use of recyclable materials, which is a substantial contribution to maintaining natural resources.

#### Batteries

In accordance with the Waste Batteries and Accumulators Regulations 2009, every consumer has a duty to return used and empty batteries. It is illegal to dispose of them in the household waste. You may bring all batteries free-of-charge to any local (council's) collection point that is part of the waste battery collection scheme. You can also send used batteries that were delivered by CES back to C.Ed. Schulte GmbH Zylinderschlossfabrik, Velbert/Germany. Please make sure correct postage is paid for the return.

Used batteries may contain contaminants or heavy metals which can pose a health and environmental hazard. Batteries are recycled, as they contain important raw materials like iron, zinc, manganese, or nickel.



The symbol with the crossed-out dust bin signifies that batteries and rechargeable batteries must not be disposed of as household waste. Beneath the symbol you may also find the chemical designation of the substances contained, e.g.:

- (Pb) lead
- (Cd) cadmium
- (Hg) mercury

Collection points for batteries and rechargeable batteries are identified by a variety of symbols.

### Package

Packaging of the components is made from environmentally friendly, reusable materials. In detail, these are:

- Outside packaging and inlays from cardboard
- Inlays and protective foils from Polyethylene (PE)



Please dispose of the packaging in an environmentally friendly way through waste separation streams.

## 14 Index

---

### B

Batteries 21

    Safety instructions 7

Battery consumption 21

Battery replacement 23

### D

Declaration of conformity 6

### E

EU Declaration of conformity 6

### F

Flyback diode 20

### N

Night locking 29

Night locking mode 29

Night locking mode ON/OFF 29

### P

Privacy mode 29

**S**

Safety instructions 6



**C. Ed. Schulte GmbH**  
**Zylinderschlossfabrik**

Friedrichstraße 243

D-42551 Velbert

☎ +49 2051 204 0

☎ +49 2051 204 229

@ info@ces.eu

**CESnederland B.V.**

Lage Brink 9

NL-7317 BD Apeldoorn

☎ +31 55-52 66 89 0

☎ +31 55-52 66 89 9

@ infonl@ces.eu

**CESfrance SARL**

8 Impasse Charles Petit

F-75011 Paris

☎ +33 1 44 87 07 56

☎ +33 1 43 07 35 78

@ infofr@ces.eu

**CESitalia srl**

V. d. vecchie Fondamenta, 4

Straße d. A. Gründungen 4

I-39044 Egna / Neumarkt (BZ)

☎ +39 0471 812 294

☎ +39 0471 812 294

@ info@it.ces.eu

**CESrom srl.**

Str. Metalurgistilor 3 D

RO-550137 Sibiu

☎ +40 269-206 00 2

☎ +40 269-206 00 5

@ info@ro.ces.eu

United Kingdom

**CES Security Solutions Ltd.**

Unit 4 Kendon Business Park

Maritime Close, Medway City Estate

Rochester, Kent ME2 4JF

☎ +44 1 634 713 369

☎ +44 1 634786833

@ info@uk.ces.eu

Middle East

**A.G.P Advanced German Products LLC**

PO Box 102761

UAE Dubai

☎ +971 4 885 7050

☎ +971 4 369 7051

☎ +971 4 390 8935

@ info@agp-dubai.com

Austria

**César A. Cárcamo**

Büro: Wiener Bundesstrasse 33

A-4050 Traun

☎ +43 660-73 20 311

☎ +43 732-21 00 22 2681

@ office@ces.at

Belgium

**LockingSystems**

Guy Lambrechts

Van Haefthenlaan 10

BE-2950 Kapellen

☎ +32 497 946267

@ guy.lambrechts@ces.eu

Spain

**Benidorm Locks S.L.**

Av. Marina Baixa s / n

Partida Torrent

ES-03530 La Nucia, Alicante

☎ +34 96 689 79 79

☎ +34 96 689 79 78

@ info@benidormlocks.com