

# CESeasy

## Motor cylinder



### Assembly and Operating Manual

 English

Version VC1

BRO2274-1

## Contents

<b>1 About this manual</b> .....	<b>4</b>
1.1 Design characteristics .....	4
1.2 Target group of this manual .....	4
<b>2 Manufacturer's information</b> .....	<b>5</b>
2.1 Manufacturer and service .....	5
2.2 Manufacturer's warranty .....	5
<b>3 For your safety</b> .....	<b>6</b>
3.1 EU Declaration of conformity .....	6
3.2 Intended use .....	6
3.3 Basic safety instructions .....	6
3.4 Notes on dealing with batteries .....	7
<b>4 About CESeasy motor cylinders</b> .....	<b>9</b>
4.1 About CESeasy motor cylinders .....	9
4.2 Scope of application .....	9
4.3 Notes about burglary protection .....	9
<b>5 Mechanical cylinder for the motor cylinder</b> .....	<b>10</b>
5.1 Before ordering: Check cylinder length .....	10
<b>6 Scope of delivery</b> .....	<b>11</b>
<b>7 Assembly</b> .....	<b>13</b>
7.1 Disassembly of the existing cylinder .....	13
7.2 Assembly of the CESeasy motor cylinder .....	14
<b>8 Batteries</b> .....	<b>17</b>
8.1 Required batteries .....	17
8.2 Battery consumption .....	17
8.3 Battery warnings .....	17
8.4 How to insert and change batteries .....	18
8.5 Battery disposal .....	20

<b>9</b>	<b>Configuration</b>	<b>21</b>
9.1	CESeasy app	21
9.2	Coupling	22
9.3	Configuration menu	25
<b>10</b>	<b>Firmware update</b>	<b>27</b>
10.1	Automatic firmware updates	27
10.2	Manual firmware updates	27
<b>11</b>	<b>Administration</b>	<b>28</b>
11.1	CESeasy web platform	28
11.2	Extension functions	28
<b>12</b>	<b>Operation</b>	<b>31</b>
12.1	How to use it with the rotary knob	31
12.2	Operation with a mechanical key	32
12.3	How to use it with a remote control	32
12.4	Operation via smartphone	32
<b>13</b>	<b>Technical data</b>	<b>34</b>
13.1	Equipment features	34
13.2	Dimensions	35
<b>14</b>	<b>Optional accessories</b>	<b>36</b>
14.1	Door contact	36
14.2	Power supply unit for external power supply	39
<b>15</b>	<b>Disposal</b>	<b>41</b>
15.1	Notes on disposal	41
<b>16</b>	<b>Index</b>	<b>43</b>

## 1 About this manual



These assembly and operating instructions, hereinafter referred to as the “manual”, will help you with the assembly and in a proper, safe, and beneficial use of the CESeasy products acquired.

Anyone who assembles, administers, maintains, or disposes of CESeasy products, must have read and understood the complete contents of this manual.

If you do not understand the functions of the CESeasy products, please contact your CES partner for further information.

-  Always use the latest version of this manual. The version number of this manual is shown on the cover page. You can get the latest version free of charge from [www.ces.eu](http://www.ces.eu)

### 1.1 Design characteristics

-  Refers to other documents.
-  Marks additional information and tips.
-  Marks warnings in step-by-step instructions and specially important information.

### 1.2 Target group of this manual

This manual is intended for

- Operators

### 1.3 Trademark protection

The Bluetooth® word mark and logos are registered trademarks owned by Bluetooth SIG, Inc. and any use of such marks by CES under license. Other trademarks and trade names are those of their respective owners.

## 2 Manufacturer's information

### 2.1 Manufacturer and service

C.Ed. Schulte GmbH

Zylinderschlossfabrik

Friedrichstr. 243

42551 Velbert

Tel: +49 (0) 2051-204-0

Fax: +49 (0) 2051-204-229

[www.ces.eu](http://www.ces.eu)

### 2.2 Manufacturer's warranty

The following damage is not covered by the manufacturer's warranty:

- Damage to the exterior mechanical parts as well as subsequent damage arising from normal wear and tear.
- Damage caused by external events or influences
- Damage caused by deficient assembly
- Damage caused by deficient maintenance
- Damage caused by false operation
- Damage caused by overvoltage
- Damage caused by fire, water or smoke

All technical data and features are subject to change without prior notice. All information and data contained in this document is subject to change without prior notice. Without express written approval from C.Ed. Schulte GmbH Zylinderschlossfabrik, no part of this document may be copied or transmitted for any purposes whatsoever.

© 2022 C.Ed. Schulte GmbH Zylinderschlossfabrik, Velbert/Germany

VC1

BRO2274-1

## 3 For your safety

### 3.1 EU Declaration of conformity

You can find the EU Declaration of conformity on the Internet at [www.ces.eu](http://www.ces.eu).

### 3.2 Intended use

CESeasy products are intended to control access at doors. They are exclusively intended for this purpose and may only be used for this. They may never be altered in any way without written permission from C.Ed. Schulte GmbH Zylinderschlossfabrik.

All other uses are regarded as improper use and may lead to material damage or even personal injuries. C.Ed. Schulte GmbH Zylinderschlossfabrik assumes no liability for damage caused by improper use.

### 3.3 Basic safety instructions

CESeasy products have been built with state-of-the-art technology and established safety regulations. Nevertheless, their use may constitute function-related hazards for the user or third parties and may impair the handle set and other material assets.

Please observe all warnings and notices in this manual while assembling, configuring and using CESeasy products.

#### 3.3.1 Life-threatening danger

- CESeasy products have not been developed, tested and/or approved for access in life-threatening situations. Do not use CESeasy products on fire doors or panic doors.
- CESeasy products must be suitable for your door system. If you are in doubt, please contact the manufacturer of the door or lock to check suitability.
- All components which are required for a complete installation at your door must be CE-compliant. Please check before installation whether all components used are CE-compliant.

#### 3.3.2 Danger of personal injury

##### Danger of explosion

- Live parts may cause explosion. Do not use parts in potentially explosive areas.

### 3.3.3 Danger of damage to material assets

#### Transportation

- Do not drop the device on the floor, on hard surfaces or objects.

#### Assembly

- The device contains highly sensitive electronic components, which can be damaged or destroyed through electrostatic charges. Therefore, do not assemble the handle set in areas affected by electrostatic charge.
- For assembly and dismantling, use the tools indicated in the "Assembly" section only.
- Only use a dry or protected or indoors place for device installation.

#### Operation

- Protect the electronic components against water and other fluids.

#### Maintenance

- Always have repairs performed by qualified personnel.
- Use only the accessories and spare parts recommended by CES.

#### Danger through climatic influences

- Do not use the device in corrosive atmosphere (chlorine, ammonia, lime water)
- Do not use the device in areas with high dust formation.
- Do not use the device near heat sources.

Please observe the maximum permissible temperatures and the information on air humidity in the section "Technical Data".

## 3.4 Notes on dealing with batteries

- Always insert new batteries only. Never use old and new batteries together.
- Before inserting the batteries, check whether the contacts in the device and on the batteries are clean. Otherwise, clean them. Do not touch the contacts after the cleaning process.
- When inserting the batteries, ensure that the polarity is correct (+/-).
- Never try to recharge the batteries. There is a risk of explosion!
- Do not short-circuit the batteries.
- Store batteries in a cool and dry place. Direct heat may damage the batteries. Therefore, do not expose battery-operated devices to any strong heat source, and do not throw the batteries into fire.

- If you do not use devices for a longer time, take out the batteries.
- Remove leaking batteries immediately from the device. Clean the contacts before inserting new batteries. There is danger of injury from battery acid.
- Remove the empty batteries from the device.
- Please take note of the information on battery disposal (see "[Disposal](#)" on page 41).



## 4 About CESeasy motor cylinders

### 4.1 About CESeasy motor cylinders

The CESeasy motor cylinder has been developed to grant access in a comfortable way. At the same time, the smartphone or remote control are the keys. The digital keys required for this kind of access are easily managed on the CESeasy web platform.

### 4.2 Scope of application

The CESeasy motor cylinder is suitable for doors with a lock with euro profile cylinders below the handle set.



CESeasy products have not been developed, tested and/or approved for access to escape and emergency routes. Do not use CESeasy products on fire doors or panic doors.

### 4.3 Notes about burglary protection

- Use CESeasy products with break-in resistance together with a handle set.
- To maintain the break-in resistance of a cylinder, it **must never project more than 3 mm beyond the surface of the handle set**. Make sure to use the correct cylinder length for your handle set.

## 5 Mechanical cylinder for the motor cylinder

### 5.1 Before ordering: Check cylinder length

Before a CESeasy motor cylinder is ordered, the length of the mechanical cylinder has to be checked.

**Tools required:**



Folding rule or calliper gauge

**How to proceed:**

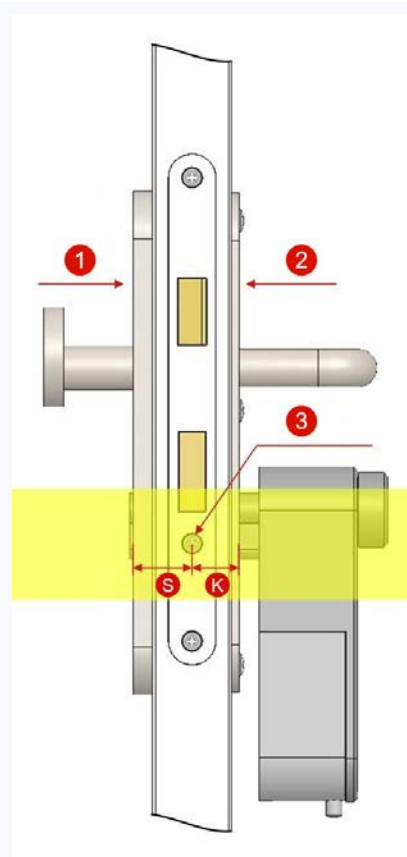

**1. Determine the dimensions for the outside (S) and the inside (K) of the cylinder.**

-  Outside (S): Measure from the middle of the cylinder fixing screw (3) to the end of the outside fitting (1).
- Inside (S): Measure from the middle of the cylinder fixing screw (3) to the end of the inside fitting (2).

**2. Indicate the exact dimensions for the exterior and the interior together with your order.**

*From the measurements indicated, CES determines the mechanical cylinder which matches your motor cylinder. You will receive the motor cylinder with a pre-assembled mechanical cylinder.*

-  To maintain the break-in resistance of a cylinder, it **must never project more than 3 mm beyond the surface of the handle set**. Make sure to use the correct cylinder length for your handle set.

## 6 Scope of delivery

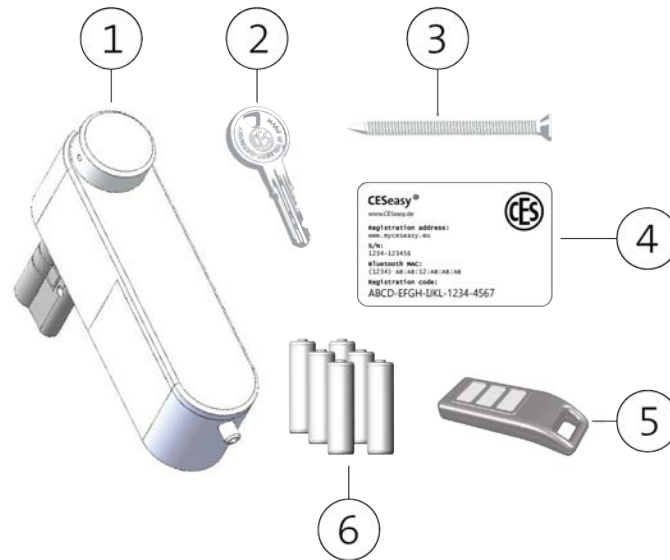

1	1 CESeasy motor cylinder (CESeasy motor unit with mounted mechanical cylinder)
2	1 Key
3	1 Cylinder fixing screw
4	1 Registration card (incl. extension function "Lock management, see <a href="#">"Extension functions"</a> on page 28)
5	1 Remote control (only part of the starter set)
6	6 Batteries

### Registration card

You will find important information on the registration card about your device, including the registration code. You need it to create a lock owner account or to add your device to the already existing lock owner account.

The registration card contains the following information:



**Registration address**

The URL you can use to create a lock owner account.

**S/N**

Serial number of the device. It must coincide with the serial number on your device:

For motor cylinders: Serial number on the sticker in the battery compartment and on the back of the motor cylinder.

For door controllers: Serial number on the sticker in the casing beneath the battery compartment and on the back of the door controller.

**Bluetooth MAC address**

The unique Bluetooth MAC address of the device.

**Registration code**

You need this code to register your device in your lock owner account. If you do not have a lock owner account yet, you need the registration code to create your lock owner account.



Keep your registration card in a safe place. You will need it in a service situation, or if you want to transfer the lock to another lock owner account.

## 7 Assembly

-  It is recommended to have CESeasy products installed and configured by CES partners. They are not only familiar with the products, but rather also with your door. Therefore, they can guarantee that the devices work correctly.

### 7.1 Disassembly of the existing cylinder

-  To be able to remove the cylinder, it may sometimes be necessary to slightly loosen the screws of the existing handle set.

#### Tools required:

The required tool depends on the cylinder fixing screw of the existing cylinder.

#### Disassembly of the existing cylinder

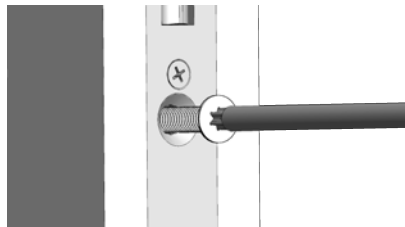

1. Loosen the cylinder fixing screw of the existing cylinder.

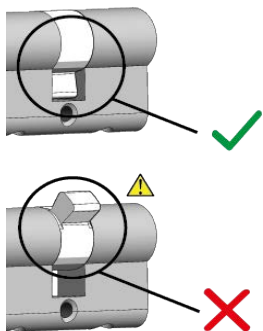



2. Remove the existing cylinder.

-  Use the key to turn the locking cam of the existing cylinder so that the cylinder can be removed from the door.

## 7.2 Assembly of the CESeasy motor cylinder

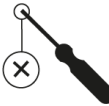
### Tools required

Tool		Required for
	<p>PZ2 Phillips screwdriver</p>	<p>Cylinder fixing screw</p>
	<p>Smartphone with CESeasy app</p> <p><b>Smartphone prerequisites:</b></p> <ul style="list-style-type: none"> <li>• iOS (iOS 9.2 or higher) or Android (Android 4.4 or higher)                             <ul style="list-style-type: none"> <li>• If you use an iPhone: iPhone 4S or newer models</li> </ul> </li> <li>• Bluetooth 4.0 or higher</li> <li>• suitable for Bluetooth Low Energy</li> </ul>	<p>Configuration and test of the motor cylinder</p>

### Assembly of the CESeasy motor cylinder

1. Remove all possibly existing batteries from the motor cylinder.

---

2. Fix the existing handle set tightly enough to insert the cylinder with ease in the door.

 This step is necessary because after having attached the motor cylinder, it will no longer be possible to fasten the handle set.

---

3. Use the knob of the motor cylinder to turn the locking cam far enough so as not to be an obstacle.

---

4. Push the cylinder into the door.

---

5. Tighten the cylinder fixing screw by hand. Do not use a cordless screwdriver or similar tools.

 If you fasten the cylinder fixing screw too strongly the service life of the cylinder may be reduced!

---

 Please also follow any assembly instructions given by the manufacturer of the cylinder which is attached to the motor cylinder.

---

6. Insert the batteries.

 Please also refer to chapter "[Batteries](#)" on page 17.

---

7. Check that the motor cylinder works correctly with *the open door*:

- Turn the knob of the motor cylinder manually.
- Use a key for the mechanical cylinder.

8. Carry out a firmware update. To do so, connect the motor cylinder with the CESeasy app (see "Coupling" on page 22), and click on UPDATE.

---

9. Configure the motor cylinder (see "Configuration" on page 21).

---

10. Check that the motor cylinder works correctly with the CESeasy app with *the open door*.

---

11. Check that the motor cylinder works correctly with the CESeasy app with the closed door.  
*Now the motor cylinder is ready.*

### Troubleshooting

To check whether the motor cylinder works correctly, check every solution described above first with an *open* door and then with a closed door.

Problem	Solution
The motor cylinder does not lock or unlock correctly	<ol style="list-style-type: none"> <li>1. Adjust the door correctly.</li> <li>2. Check whether the locking plates are installed correctly.</li> <li>3. Ask a service technician to adapt the parameters in the expert settings of the configuration menu.</li> </ol>



## 8 Batteries

### 8.1 Required batteries

You need six AA alkaline batteries.

### 8.2 Battery consumption

Battery consumption of the motor cylinder depends, amongst others, on the following factors:

- Quality and capacity of the batteries. The higher the capacity, the longer the batteries will last.
- The time the motor cylinder requires to turn the lock in order to lock or unlock the door. The longer the motor cylinder is in operation, the quicker the batteries run down.
- The force the motor cylinder has to apply. If, for example, the door is warped, the motor cylinder has to apply a higher force, and the batteries run down more quickly.
- Ambient temperature. If ambient temperatures are lower, battery service life will be reduced.
- The “Automatic closure” function: If this function is used, the motor cylinder automatically locks the door after it has been closed (requires a door contact). This function runs down the batteries more quickly.
- The opening times set, i.e. the period during which the latchbolt is retrieved and kept in its position by the motor cylinder. Prolonged opening times reduce battery life.

### 8.3 Battery warnings

#### **Battery warning emitted by the motor cylinder**

If the batteries are nearly empty, the device emits the usual acoustic signal after an opening or closing operation, and then three acoustic battery warning signals (--- --- ---).



The battery warning signals are also emitted if you have switched off the normal acoustic signal via the configuration settings.

#### **Battery warning in the CESeasy app**

If the batteries are nearly empty, a pop-up window opens in the CESeasy app after an opening or closing operation which informs you about the battery status.

If the battery warning shows that the batteries are nearly empty, the door controller will continue to work for some more time. However, the duration of this period depends strongly on the aspects mentioned in the section "[Battery consumption](#)" on the previous page.

## 8.4 How to insert and change batteries

 Please refer to chapter "[Disposal](#)" on page 41 when changing the batteries.

### Tools required:

You can manually remove the design screw of the battery compartment. If the design screw is too tight, you can loosen it with an Allen key (4mm).

 If you want to prevent that the battery compartment can be manually opened, you can replace the design screw by a safety screw (M4 thread, length 8mm).

**How to insert and change batteries**

1. Loosen the design screw.

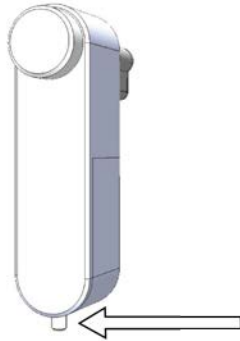

2. Slide the cover of the battery compartment downwards and remove it.

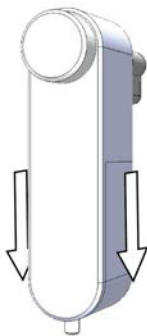

3. If necessary, take out the six empty batteries.

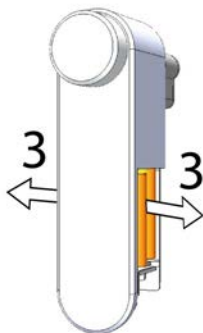

4. Insert the six new batteries.

 Please ensure that the batteries are inserted according to the labelling in the battery compartment which indicates the correct polarity.

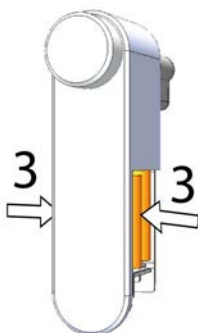

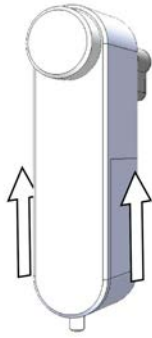

5. Slide the cover back onto the battery compartment.



6. Tighten the design screw by hand.

*The batteries are now inserted or have been changed.*

## 8.5 Battery disposal

See "Disposal" on page 41.

## 9 Configuration

-  It is recommended to have CESeasy products installed and configured by CES partners. They are not only familiar with the products, but rather also with your door. Therefore, they can guarantee that the devices work correctly.

### 9.1 CESeasy app

For configuration you need the CESeasy app.

The CESeasy app is available for Android and iPhone. Simply scan the QR code to download the app.

-  The QR code is able to detect whether you are using an Android phone or iPhone, and refers you to the correct app.

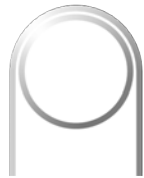

CESeasy app "access"



If the scan does not work, please open the following link on your smartphone. The link is also able to detect whether you are using an Android phone or iPhone, and refers you to the correct app.

<https://ces.qr1.at/CESeasyApp>

#### Smartphone prerequisites:

- iOS (iOS 9.2 or higher) or Android (Android 4.4 or higher)
  - If you use an iPhone: iPhone 4S or newer models
- Bluetooth 4.0 or higher
- suitable for Bluetooth Low Energy

#### Location transmission

To enable the CESeasy app to connect to the lock, the location transmission must be activated. This applies to both the settings of **the app itself** (CESeasy app must be allowed to share the location) and the location transmission **of your smartphone** (location transmission must be activated for the smartphone).

-  If you use an Android smartphone, you may have to set the location transmission once manually in the settings of the CESeasy app after it has been installed.

## 9.2 Coupling

For safety reasons, the motor cylinder has to be connected to the app for manual firmware updates and configuration. Thus, only people with a direct access to the motor cylinder can update and configure it.

### Tools required

Tool	Required for
 <p>Smartphone with CESeasy app</p> <p><b>Smartphone prerequisites:</b></p> <ul style="list-style-type: none"> <li>• iOS (iOS 9.2 or higher) or Android (Android 4.4 or higher)                             <ul style="list-style-type: none"> <li>• If you use an iPhone: iPhone 4S or newer models</li> </ul> </li> <li>• Bluetooth 4.0 or higher</li> <li>• suitable for Bluetooth Low Energy</li> </ul>	<p>Configuration, firmware update and test</p>

### How to couple the motor cylinder with the CESeasy app

1. Loosen the design screw.



2. Slide the cover of the battery compartment downwards and remove it.

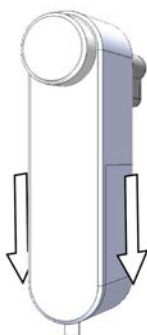

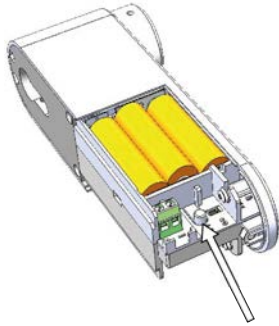

**3. Press the coupling button in the battery compartment of the motor cylinder for approx. 1 second.**

*Now, the motor cylinder periodically emits an acoustic signal.*

 The motor cylinder has to be within the range of the smartphone.



**4. Open the CESeasy app on your smartphone.**

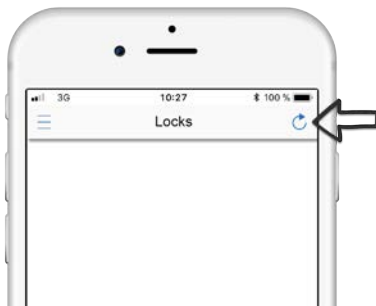

**5. Make sure you are in the “Locks” menu of the app. Click on the “Scan” button  in the upper right corner.**



*In the menu options “Update” and “Config” you will now see the motor cylinder.*

 As long as the motor cylinder is connected to the app, it regularly emits an acoustic signal. This shows that both are connected.



6. If you click on “Config”, the configuration menu opens (see ["Configuration menu"](#) on the facing page).

-  Make sure that you have carried out the **first** firmware update **before** configuring the device. Otherwise, your configuration will be overwritten by the first firmware update. No subsequent firmware updates will overwrite your configuration.



7. If you click on “Update”, a firmware update is carried out (see ["Firmware update"](#) on page 27).



## 9.3 Configuration menu

-  Make sure that you have carried out the **first** firmware update **before** configuring the device. Otherwise, your configuration will be overwritten by the first firmware update. No subsequent firmware updates will overwrite your configuration.

### Test



For safety reasons, always test the functions when the door is open!

#### Night

Tests the “Night locking” mode

If in night locking mode, the motor cylinder locks the door, which then no longer can be mechanically opened. If someone tries to turn the rotary knob in the opening direction, the motor cylinder exerts some force turning it in the closing direction. The night locking mode is a break-in resistance property intended e.g. to prevent someone from turning the rotary knob of the motor cylinder from the outside through the mail slot.



The night locking mode is deactivated when the lock is opened by remote control or the CESeasy app.



To be able to open a door which is in night locking mode, you must have a remote control or the CESeasy app. In an emergency, this could lead to life-threatening situations!



Before you activate the night locking mode, be sure to note all requirements concerning escape routes and fire protection (e.g. certain doors must not be locked).



When in night locking mode, the motor prevents the knob from being manually turned by exerting force in the opposite direction. This uses a lot of battery energy, which is why they may empty more quickly when in night locking mode.

#### Close

Locks the lock

#### Open

Unlocks the lock



You can reverse the direction of rotation if the motor cylinder rotates in the wrong direction during “Open” and “Close” (see below).

### Configuration

#### Acoustic signal





Acoustic signal after each closing/opening operation yes/no

#### Reverse direction of rotation

Changes the rotational direction of the motor. You have to change the direction of rotation if the “Open” test shows that the motor rotates in the wrong direction.

#### Automatic closure

If the function “Automatic closure” is activated, the motor cylinder automatically locks the door after it has been closed.

	<p> This function requires a door contact.</p> <p> The “Automatic closure” function increases the battery consumption.</p>
Opening time	<p>Contains the settings for the time period the latch is pulled back.</p> <p> Prolonged opening times increase battery consumption.</p>
Using the door status sensor	<p>Here, if there is a door contact, you can define whether that door contact should be used.</p>
Reversing the door status sensor	<p>Here you can reverse the signal of the door contact if the door contact signals “door open” when the door is closed.</p>
Type	<p>Lock type, e.g. motor cylinder or door controller</p>
Power supply unit	<p>Indicates whether an optional power supply unit is connected or not.</p>
Battery	<p>Indicates the battery voltage measured in the device.</p>
Firmware	<p>Shows the firmware version of the device.</p>
Advanced	<p>Opens the expert menu for the CES service technician.</p> <p> To ensure that only trained experts can change the settings in the expert menu, it is protected by a PIN code.</p>

## 10 Firmware update

### 10.1 Automatic firmware updates

#### Automatic firmware update after installation

The first firmware update after installation should be carried out manually. However, if this has not happened, the firmware update is carried out automatically after the device has been operated by the CESeasy App. In this case, the CESeasy app shows a message, and the firmware update will be completed after approx. 45 seconds.

#### Automatic firmware updates during operation

Firmware updates are automatically transmitted during operation by the CESeasy app. As soon as the new firmware has been transmitted completely, the device operates on the new firmware. Usually you do not notice the updating process.

### 10.2 Manual firmware updates

The following situations require a manual firmware update:

- The motor cylinder has been installed for the first time
- The motor cylinder has been reset to factory settings

#### How to proceed

See "[Coupling](#)" on page 22.



 Make sure that you have carried out the **first** firmware update **before** configuring the device. Otherwise, your configuration will be overwritten by the first firmware update. No subsequent firmware updates will overwrite your configuration.

 A message is shown that the transmitted firmware has been installed once the firmware has been transmitted completely. The motor cylinder emits a signal to indicate that the firmware installation has been completed. Firmware installation takes about 30 seconds.

## 11 Administration

### 11.1 CESeasy web platform

The device is managed on the CESeasy web platform. There you can issue keys, add remote controls, etc.



For details, please refer to the [manual for the CESeasy web platform](#).

### 11.2 Extension functions

Several extension functions are available at CES.

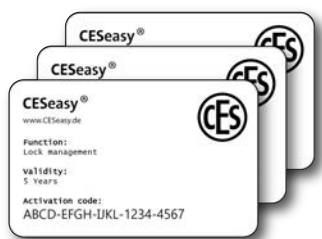

You can purchase these functions in the form of a prepaid card which contains a code. Scratch the code off and add it to your lock or account.



#### Lock management (for locks)



The "Lock management" function is part of the locks as delivered by CESeasy.



The "Lock management" function allows you to manage your locks for 5 years on the web platform without any restrictions. You can extend it for another five years by buying an additional "Lock management" function.

When "Lock management" has expired, lock management will be restricted:

- You can no longer issue keys for this lock, you can only retrieve them. (The keys issued before this period expired are preserved)
- It is no longer possible to link a lock to a button of the remote control. (Buttons linked to a lock before this period expired are preserved)
- If no lock in your account has the "Lock management" function any longer, you can no longer add a remote control.  
(The remote controls added before this period expired are preserved)





"Lock management" is linked to each lock.

-  The time starts to run upon the first lock registration. If you delete a lock, the functions linked to it continue to be activated, and time continues to run. If this lock is registered again, it is added to the account with the remaining time.
-  If you have activated the "5 additional keys" function for a lock, you can issue and retrieve these keys for the lock in question only within the validity period. The additional keys do not prolong the term of expiration.



#### **5 additional keys (for locks)**



This function provides you with five additional keys for one lock. Additional keys are only valid for the lock to which you have added this extension function.

-  You can issue additional keys for one lock as long as you can also issue the keys which were delivered to you together with the lock.
-  When you delete a lock you also delete all additional keys which were added to this lock. Afterwards, these additional keys cannot be added to another lock.



#### **Key to organisation (for locks)**

This function allows you to issue keys not only to individuals but rather also to organisations. The organisation which has received a key from you can pass it on to its employees.

-  This function is valid for five years. The time during which this function is valid starts to run after you have added this function to the lock. If you delete the lock, time continues to run. If this lock is registered again, it is added to the account with its remaining time.
-  The "Key to organisation" function can only be added and used if a valid "Lock management" function has been added to it. The "Lock management" function is part of the locks as delivered by CESeasy.



#### **Building management (for lock owner accounts)**

The "Building management" function allows you to manage buildings in the role of a building manager. Your account is extended with the tab "Buildings" which allows you to create buildings and to add locks to these buildings. If you own the "Building management" function, you can additionally define how the name of the lock is displayed on the web platform and in the CESeasy app.

The "Building management" function is used to extend two account types:



- If you extend a **lock owner account** with the “Building management” function, you have a lock owner account with building management.
- If you extend an **organisation account** with the “Building management” function, you have a lock owner account with building management in addition to your organisation account. You can switch between the accounts on the web platform.

The “Building management” function is valid for five years. It is linked to your lock owner account.



**100 employees (for an organisation)**

You can use the “100 employees” function in two ways:

- It allows you to manage 100 additional employees in your organisation. Initially, you can manage 100 employees per organisation, while this function allows you to manage 200 employees in your organisation (or even more, if you buy this function several times).
-  If you manage several organisations with your organisation account: these 100 additional employees are added only to the organisation you have selected when activating this function.
-  The “100 employees” function has a duration of five years.
- When the licence duration of your organisation has expired, you can prolong it by another five years with the “100 employees” function.



**Organisation (for organisation accounts)**

You can use the “Organisation” function in two ways:

- It allows you to create an organisation account. This account automatically creates an organisation with 100 employees.
- If you already own an organisation account, this function allows you to add another organisation with 100 employees.
-  One organisation has a validity of 5 years. To extend its validity by another 5 years, you have to add the function “100 employees” to this organisation.

## 12 Operation

### 12.1 How to use it with the rotary knob

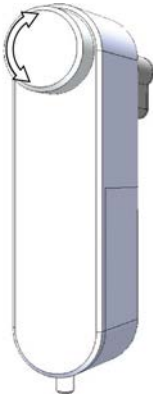



The door can easily be locked or unlocked using the rotary knob. As soon as you move the rotary knob in the direction “Lock” or “Unlock”, the motor cylinder detects the movement and locks or unlocks the door.

#### **Night locking mode:**

If in night locking mode, the motor cylinder locks the door, which then no longer can be mechanically opened. If someone tries to turn the rotary knob in the opening direction, the motor cylinder exerts some force turning it in the closing direction. The night locking mode is a break-in resistance property intended e.g. to prevent someone from turning the rotary knob of the motor cylinder from the outside through the mail slot.

 The night locking mode is deactivated when the lock is opened by remote control or the CESeasy app.

 To be able to open a door which is in night locking mode, you must have a remote control or the CESeasy app. In an emergency, this could lead to life-threatening situations!

 Before you activate the night locking mode, be sure to note all requirements concerning escape routes and fire protection (e.g. certain doors must not be locked).

 When in night locking mode, the motor prevents the knob from being manually turned by exerting force in the opposite direction. This uses a lot of battery energy, which is why they may empty more quickly when in night locking mode.

## 12.2 Operation with a mechanical key



You can always lock and unlock your door with a mechanical key from the outside. A specific coupling in the motor cylinder disengages it as soon as you insert a key into the mechanical cylinder.

-  However, you should always carry a mechanical key with you even if you operate your motor cylinder by smartphone or remote control only. You can use it in an emergency, e.g. if the batteries of the motor cylinder, the remote control or your smartphone are empty.

## 12.3 How to use it with a remote control



You can also operate the CESeasy motor cylinder with a remote control. Press a button of the remote control not too far away from the motor cylinder. The lock owner defines the functions assigned to the buttons of the remote control.

-  For details, please refer to the [manual for the CESeasy remote control](#).

### Remote control range

The remote control range depends on various factors:

- The lock environment (building materials of doors, walls, etc.)
- The remote control environment (the way it is held, if it is used inside or outside, etc.)
- The surrounding environment between lock and remote control (doors and walls between them, further radio signals in the surroundings which could influence the communication, etc.)

## 12.4 Operation via smartphone



You can operate the motor cylinder by means of the CESeasy app and a suitable smartphone.

To operate the motor cylinder, you need a digital key. You can assign digital keys to yourself or others on the CESeasy web platform.

-  For details, please refer to the [manual for the CESeasy web platform](#).



### How to download the CESeasy app

The CESeasy app is available for Android and iPhone. Simply scan the QR code to download the app.

-  The QR code is able to detect whether you are using an Android phone or iPhone, and refers you to the correct app.

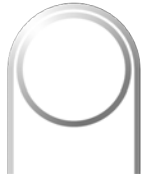

CESeasy app "access"



If the scan does not work, please open the following link on your smartphone. The link is also able to detect whether you are using an Android phone or iPhone, and refers you to the correct app.

<https://ces.qr1.at/CESeasyApp>

#### Smartphone prerequisites:

- iOS (iOS 9.2 or higher) or Android (Android 4.4 or higher)
  - If you use an iPhone: iPhone 4S or newer models
- Bluetooth 4.0 or higher
- suitable for Bluetooth Low Energy

#### Location transmission

To enable the CESeasy app to connect to the lock, the location transmission must be activated. This applies to both the settings of **the app itself** (CESeasy app must be allowed to share the location) and the location transmission **of your smartphone** (location transmission must be activated for the smartphone).

-  If you use an Android smartphone, you may have to set the location transmission once manually in the settings of the CESeasy app after it has been installed.

## 13 Technical data

### 13.1 Equipment features

<b>CESeasy motor cylinder</b>	
<b>Article number</b>	Motorised cylinder: 347100V Complete package: EASY-xxx (xxx = profile range, e.g. WD5): Motor cylinder with mounted locking cylinder, 1 mechanical key, 5 digital keys, 1 remote control, 1 "lock management" function (5 years), door contact and connecting cable for door contact
<b>Material</b>	ABS, lacquered / anodized aluminium
<b>Locking cylinder</b>	Each state-of-the-art CES locking system, incl. 1 key
<b>Cylinder profile</b>	Euro profile (PZ); optionally Swiss round profile (22mm)
<b>Power supply</b>	
<b>Batteries</b>	6 x AA alkaline batteries
<b>Power input</b>	12 VDC / 2.5 A / stabilised
<b>Optional power supply unit</b>	347130V
<b>Inputs and outputs</b>	
<b>Sensor input</b>	Input for an optional door contact (347129V). A special cable is required (347110V). Set containing a door contact and a cable: 347128V Max. cable length: 30 cm
<b>Further inputs and outputs</b>	Available via the CESeasy communication module
<b>RF-Transceiver</b>	
<b>RF-Transceiver</b>	868 MHz, for remote controls and the communication module
<b>Bluetooth® Low Energy Transc.</b>	2.4 GHz, to communicate with mobile phones
<b>Encryption</b>	AES128
<b>Memory / capacity</b>	
<b>Number of digital keys</b>	600 access group (1 access group = max. 65,000 employee keys, or 1 digital key, or 1 remote control)
<b>Encryption</b>	AES128
<b>Service life</b>	
<b>Service life</b>	Min. 200.000 operations (at 20°C), in accordance with SKG
<b>Battery service life</b>	Approx. 7,500 operations (2 turns, latch and deadbolt, 1 Nm, at 20°C) in one year
<b>Environment</b>	
<b>Device environment</b>	The device side equipped with motor is suitable for indoor use only
<b>Operating temperature</b>	0 ... + 50°C
<b>Humidity during operation</b>	5 ... 90%, non-condensing
<b>Unsuitable climates</b>	Do not use in corrosive environments (chlorine, ammonia, lime water)
<b>Tests and certificates</b>	
<b>Safety class</b>	SKG***
<b>CE label</b>	NEN EN 300330-02, NEN EN 301489-03
<b>Control and operation</b>	
<b>Mobile phone</b>	Compatible Apple device (Bluetooth® Low Energy and iOS 9.2 or higher) Compatible* Android device (Bluetooth® Low Energy and Android 4.4 or higher)

\* Due to the vast number of different Android phones and versions, testing the compatibility of a particular Android device is recommended.

### 13.2 Dimensions

#### 13.2.1 Case with a mechanical cylinder

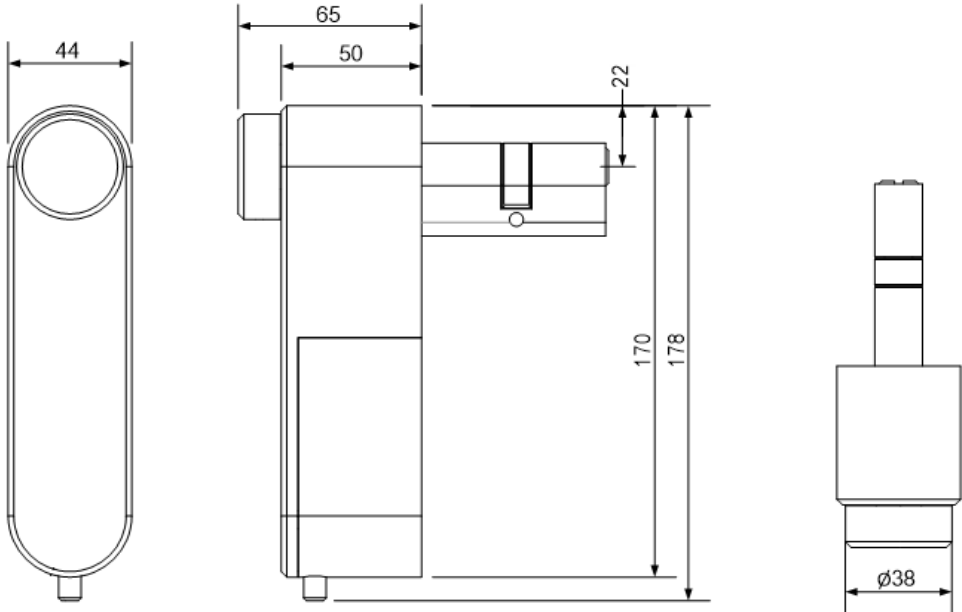

## 14 Optional accessories

### 14.1 Door contact

The door contact transmits the information “door is locked” or “door is open” to the lock. This information can be used for motor cylinders and door controllers.

A door contact allows you to use the “Automatic closure” function. The door contact enables the motor cylinder to detect that the door is closed and thus automatically lock it.

 The “Automatic closure” function increases the battery consumption.

You can use standard reed switches as door contacts. To connect the door contact to the motor cylinder you need a connecting cable with a special plug. Both are available at CES:

Door contact	347129V
Connecting cable	347110V
Set containing a door contact and a connecting cable	347128V

#### 14.1.1 How to install a door contact

##### How to install a door contact

1. Loosen the design screw by hand.



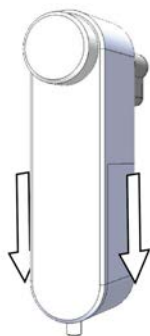

2. Slide the cover of the battery compartment downwards and remove it.

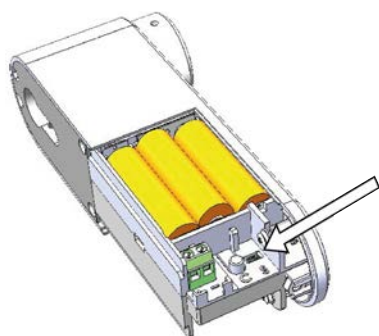

3. Insert the plug of the door contact cable into the intended port (see image).

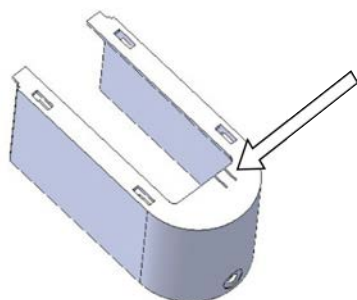

4. Remove the lug in the cover of the battery compartment.

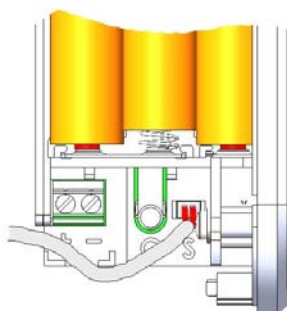

5. Run the connecting cable through the recess into the motor cylinder (see picture).

6. Slide the cover back onto the battery compartment.

-  Make sure that the power cable runs into the cover through the new opening (removed lug).
- 

**7. Install the door contact directly next to the motor cylinder and the door. In doing so, follow the instructions for the door contact.**

---

**8. Mount the magnet which belongs to the door contact onto the door frame opposite the door contact.**

---

**9. Connect the connecting cable to the door contact.**

-  If necessary, you can shorten the connecting cable, but you cannot extend it. The door contact cable must not exceed approx. 25cm. A cable which is too long may lead to unintended behaviour.
- 

**10. In the configuration menu, activate the use of the door contact (see "[Configuration](#)" on page 21).**

## 14.2 Power supply unit for external power supply

The motor cylinder can be connected to an external power supply unit.

### Requirements of the power supply unit:

- Stabilised DC voltage of 12V ± 10%
- Current of max. 2.5A

### 14.2.1 How to connect the power supply unit

#### Tools required

Tool	e.g. by
0.5 x 3.0 x 80 wrench	Wera 335(5110001001)

#### How to connect the power supply unit



1. Loosen the design screw by hand.

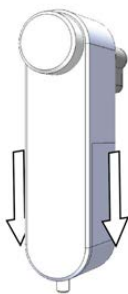

2. Slide the cover of the battery compartment downwards and remove it.

3. Cut the wire ends to 6mm length.



Make sure that the wire ends are either tin-plated or carry suitable wire end sleeves.

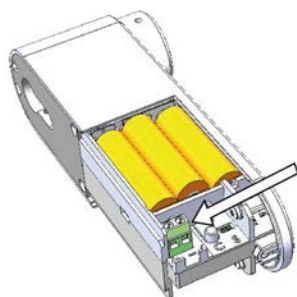

**4. Push the wire ends into the connector, and carefully tighten them.**

-  Make sure to connect the cable correctly to the positive and negative terminals as indicated in the connector of the motor cylinder case.
  - + next to the bottom side
  - next to the button

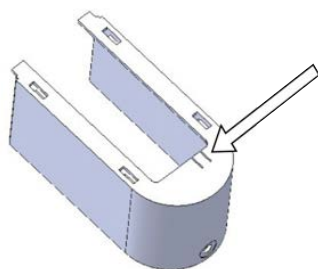

**5. Remove the lug in the cover of the battery compartment.**

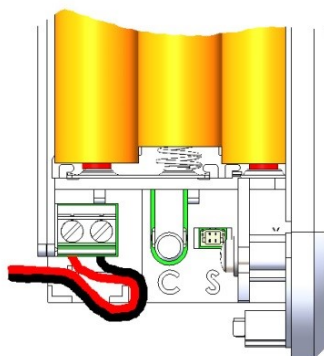

**6. Run the power cable through the recess into the motor cylinder (see picture).**

**7. Slide the cover back onto the battery compartment.**

-  Make sure that the power cable runs into the cover through the new opening (removed lug).

*Now the external power supply unit is connected.*

-  It is recommended to additionally insert batteries which ensure that the motor cylinder can also be used in the event of a power outage.



## 15 Disposal

### 15.1 Notes on disposal

#### Device

In accordance with the Waste Electrical and Electronic Equipment recycling (WEEE) Regulations, every consumer has a duty to dispose of old electronic/electrical appliances safely and separately from household waste. It is forbidden to dispose of electronic devices in the household waste. You can bring old devices free of charge to the local (council's) collection points. Or you can send the device to C.Ed. Schulte GmbH Zylinderschlossfabrik, Velbert/Germany. Please make sure correct postage is paid for the return.



The symbol with the crossed-out dust bin signifies old electrical appliances must not be disposed of as household waste.

Electronic devices contain many different substances and materials. If old electronic devices are not disposed of appropriately, the contaminants contained in them can lead to health and environmental hazards. In addition, appropriate disposal allows recovery and re-use of recyclable materials, which is a substantial contribution to maintaining natural resources.

#### Batteries

In accordance with the Waste Batteries and Accumulators Regulations 2009, every consumer has a duty to return used and empty batteries. It is illegal to dispose of them in the household waste. You may bring all batteries free-of-charge to any local (council's) collection point that is part of the waste battery collection scheme. You can also send used batteries that were delivered by CES back to C.Ed. Schulte GmbH Zylinderschlossfabrik, Velbert/Germany. Please make sure correct postage is paid for the return.

Used batteries may contain contaminants or heavy metals which can pose a health and environmental hazard. Batteries are recycled, as they contain important raw materials like iron, zinc, manganese, or nickel.



The symbol with the crossed-out dust bin signifies that batteries and rechargeable batteries must not be disposed of as household waste. Beneath the symbol you may also find the chemical designation of the substances contained, e.g.:

- (Pb) lead
- (Cd) cadmium
- (Hg) mercury

Collection points for batteries and rechargeable batteries are identified by a variety of symbols.

### Package

Packaging of the components is made from environmentally friendly, reusable materials. In detail, these are:

- Outside packaging and inlays from cardboard
- Inlays and protective foils from Polyethylene (PE)



Please dispose of the packaging in an environmentally friendly way through waste separation streams.

## 16 Index

---

### 1

100 employees (extension function) 30

### 5

5 additional keys (extension function) 29

### A

App 21

### B

Batteries

    Safety instructions 7

Battery consumption 17

Battery replacement 18

Building management (extension function) 29

### C

CESeasy app 21

CESeasy web platform 28

Configuration 21

Coupling 22

Coupling button 23

Cylinder length (mechanical cylinder) 10

**D**

Declaration of conformity 6

Dimensions 35

Door contact 36

    Assembly 36

**E**

EU Declaration of conformity 6

Extension functions 28

**F**

Firmware update 27

Functions (extension functions) 28

**H**

High burglary protection 9

**K**

Key

    mechanical 32

Key to organisation 29

**L**

Lock management (extension function) 28

## M

Mechanical cylinder 10

## N

Night locking mode 31

## O

Organisation (extension function) 30

## P

Power supply unit 39

    Connection 39

## R

Registration card 11

Remote control 32

Rotary knob 31

## S

Safety instructions 6

Scope of delivery 11

## W

Web platform 28

Teaming up for security  
*since 1840*



**C. Ed. Schulte GmbH**  
**Zylinderschlossfabrik**  
Friedrichstraße 243  
D-42551 Velbert

Tel: +49 (0) 2051-204-0  
Fax: +49 (0) 2051-204-229  
[info@ces.eu](mailto:info@ces.eu)

[www.ces.eu](http://www.ces.eu)